

2015

Cameron Decomposition Applied to Polarimetric Synthetic Aperture Radar Signature Detection

Sean Winger
University of South Carolina

Follow this and additional works at: <http://scholarcommons.sc.edu/etd>

 Part of the [Electrical and Computer Engineering Commons](#)

Recommended Citation

Winger, S.(2015). *Cameron Decomposition Applied to Polarimetric Synthetic Aperture Radar Signature Detection*. (Master's thesis). Retrieved from <http://scholarcommons.sc.edu/etd/3579>

This Open Access Thesis is brought to you for free and open access by Scholar Commons. It has been accepted for inclusion in Theses and Dissertations by an authorized administrator of Scholar Commons. For more information, please contact SCHOLARC@mailbox.sc.edu.

Cameron Decomposition Applied to Polarimetric Synthetic Aperture Radar Signature Detection

by

Sean Winger

Bachelor of Science
The Citadel, 2009

Submitted in Partial Fulfillment of the Requirements

For the Degree of Master of Science in

Electrical Engineering

College of Engineering and Computing

University of South Carolina

2015

Accepted by

Paul Huray, Director of Thesis

Yinchao Chen, Reader

Lacy Ford, Vice Provost and Dean of Graduate Studies

© Copyright by Sean Winger, 2015
All Rights Reserved

Acknowledgements

The author would like to acknowledge Doctor Paul Huray, Doctor Yinchao Chen, and Tanzeel Rana for their aid and contributions in the development of this thesis. The author also acknowledges and thanks Virginia Rebecca Wininger and Stella Marie Wininger for their never ending love and support.

Abstract

Cameron et al, have developed a method of decomposing scatterer scattering matrices based on Huynen's scattering matrix decomposition parameters. Huynen's decomposition parameters are not unique, in that certain transformation properties, such as the angle of symmetry itself, may misidentify a scattering matrix and therefore misidentify a particular geometric shape. Cameron decomposition derives these parameters by direct calculations from the scatterer itself so that they may not be inferred or interpreted. A detailed explanation of the foundations and method of Cameron decomposition is presented here. A description of how Cameron decomposition is implemented in Polarimetric Synthetic Aperture Radar (PolSAR) signature detection is also presented.

Table of Contents

Acknowledgements.....	iii
Abstract.....	iv
List of Figures	vi
Chapter 1 Electric Field Propagation and Polarization	1
Chapter 2 Huynen Scattering Matrix Decomposition.....	19
Chapter 3 Cameron Decomposition	48
Chapter 4 Cameron Decomposition and Polarimetric SAR Applications	69
Bibliography	76
Appendix A: MATLAB Cameron Decomposition Script.....	78

List of Figures

Figure 1.1 Polarized Electric Wave Along the Z Axis	5
Figure 1.2 Linearly Polarized Plane Wave Along the x Axis	6
Figure 1.3 Linearly Polarized Field in the Direction of ψ	7
Figure 1.4 Right-Hand Circularly Polarized Wave	9
Figure 1.5 Left-Hand Circularly Polarized Wave	10
Figure 1.6 Right and Left-Hand Elliptically Polarized Waves	13
Figure 1.7 Rotated Electromagnetic Plane Wave and It's Tilted Ellipse	15
Figure 1.8 Poincare Sphere For the Polarization State of the Wave	17
Figure 1.9 Polarization States of a Wave on a Planar Surface Projection	18
Figure 2.1 Target Aspect Direction and Orientation Angle from Huynen	20
Figure 2.2 Left Sensed Polarization Ellipse	22
Figure 2.3 Quaternion Multiplication Table	26
Figure 2.4 Poincare/Polarization Sphere from Huynen	32
Figure 2.5 Polarization Chart from Huynen	32

Figure 2.6 A Large Sphere or Flat Plate at Normal Incidence of Any Material	44
Figure 2.7 A Large Trough Oriented with Axis	44
Figure 2.8 A Large Trough with Axis Oriented at 45° or -45°	45
Figure 2.9 Reflection from a Trough	45
Figure 2.10 A Large Trough with Axis Oriented at an Arbitrary Angle ψ_a	45
Figure 2.11 Horizontal Line Target (Wire)	45
Figure 2.12 Line Target A Large with Axis Oriented at an Arbitrary Angle ψ_a	45
Figure 2.13 A Symmetric Target with Horizontal Axis	46
Figure 2.14 Symmetric Target	46
Figure 2.15 A Symmetric Target with Arbitrary Axis of Orientation	46
Figure 2.16 A Helix with Right Screw Sense	47
Figure 2.17 A Helix with Left Screw Sense	47
Figure 3.1 Scattering Matrix Classification Scheme	64
Figure 3.2 Diagram of Scatterer Types and Positions for Simple Array	66
Figure 3.3 Full Polarimetric RCS Images of a Simple Array of Scatterers	66
Figure 4.1 Signature Detections Shown for Dihedrals, Trihedrals, and Cylinders	75
Figure 4.2 Signature Detections Shown for Tail Dihedrals	75

Chapter 1

Electric Field Propagation and Polarization

An overview of electromagnetic wave polarization is presented in this chapter. It is important to provide an explanation of propagating electromagnetic plane waves, as well as geometric descriptions and analyses of polarized plane waves presented in Huray [8] and Balanis [9]. These concepts are key in understanding the physical parameters and analysis used in both Cameron [1] and Huynen's [2] decompositions.

Maxwell's equations model the time-space behavior of electromagnetic waves. In asymmetrical point form they are the following equations.

$$\vec{\nabla} \times \vec{E}(\vec{x}, t) = -\frac{\partial \vec{B}(\vec{x}, t)}{\partial t}$$

$$\vec{\nabla} \times \vec{H}(\vec{x}, t) = \vec{J}_x(\vec{x}, t) + \frac{\partial \vec{D}(\vec{x}, t)}{\partial t}$$

$$\vec{\nabla} \cdot \vec{D}(\vec{x}, t) = \rho(\vec{x}, t)$$

$$\vec{\nabla} \cdot \vec{B}(\vec{x}, t) = 0$$

where, $\vec{E}(\vec{x}, t)$ is the electric field intensity, $\vec{B}(\vec{x}, t)$ is the magnetic flux density, $\vec{H}(\vec{x}, t)$ is the magnetic field intensity, $\vec{J}_x(\vec{x}, t)$ is the electric current density, $\vec{D}(\vec{x}, t)$ is the electric flux density, and $\rho(\vec{x}, t)$ is the electric charge density. The terms t and \vec{x}

represent time and space ($\vec{x} = (\hat{x}, \hat{y}, \hat{z})$) parameters, respectively. It should be noted that the symmetrical point form of Maxwell's equations will not be used in this context because it is assumed that the magnetic current density and magnetic charge density do not exist.

In the equations above the total current density contains two components, $\vec{J}_x(\vec{x}, t) = \vec{J}_s(\vec{x}, t) + \vec{J}_c(\vec{x}, t)$. The first component, $\vec{J}_s(\vec{x}, t)$ is the source term, and $\vec{J}_c(\vec{x}, t)$ is the conduction current density, which is dependent on the conductivity, σ , of the medium in which the electro-magnetic wave is propagating.

$$\vec{J}_c(\vec{x}, t) = \sigma \vec{E}(\vec{x}, t)$$

The fields are related by the following equations,

$$\vec{D}(\vec{x}, t) = \epsilon \vec{E}(\vec{x}, t) + \vec{P}(\vec{x}, t)$$

$$\vec{B}(\vec{x}, t) = \mu \vec{H}(\vec{x}, t) + \vec{M}(\vec{x}, t)$$

where, ϵ , $\vec{P}(\vec{x}, t)$, μ , and $\vec{M}(\vec{x}, t)$ are the permittivity of the medium, polarization, permeability of the medium, and magnetization, respectively. The conditions of the propagating medium shall be considered lossless and source free. Hence, the polarization, magnetization, and electric current density are then

$$\vec{P}(\vec{x}, t) = \vec{M}(\vec{x}, t) = \vec{J}(\vec{x}, t) = \vec{0}$$

By substituting Maxwell's equations and the field relation equations above into the identity, $\vec{\nabla} \times (\vec{\nabla} \times \vec{A}) = \vec{\nabla}(\vec{\nabla} \cdot \vec{A}) - \vec{\nabla}^2 \vec{A}$, the propagation equations can be found as follows

$$\vec{\nabla} \times (\vec{\nabla} \times \vec{E}(\vec{x}, t)) = \vec{\nabla}(\vec{\nabla} \cdot \vec{E}(\vec{x}, t)) - \vec{\nabla}^2 \vec{E}(\vec{x}, t)$$

$$\vec{\nabla} \times \left(-\frac{\partial \vec{B}(\vec{x}, t)}{\partial t} \right) = \vec{\nabla} \left(\vec{\nabla} \cdot \frac{1}{\epsilon} \vec{D}(\vec{x}, t) \right) - \vec{\nabla}^2 \vec{E}(\vec{x}, t)$$

$$\vec{\nabla} \times \left(-\frac{\partial \mu \vec{H}(\vec{x}, t)}{\partial t} \right) = \vec{\nabla} \left(\frac{1}{\epsilon} \rho(\vec{x}, t) \right) - \vec{\nabla}^2 \vec{E}(\vec{x}, t)$$

$$-\frac{\partial \mu (\vec{\nabla} \times \vec{H}(\vec{x}, t))}{\partial t} = \vec{\nabla} \left(\frac{1}{\epsilon} \rho(\vec{x}, t) \right) - \vec{\nabla}^2 \vec{E}(\vec{x}, t)$$

$$-\frac{\partial \mu \left(\vec{J}_x(\vec{x}, t) + \frac{\partial \vec{D}(\vec{x}, t)}{\partial t} \right)}{\partial t} = \vec{\nabla} \left(\frac{1}{\epsilon} \rho(\vec{x}, t) \right) - \vec{\nabla}^2 \vec{E}(\vec{x}, t)$$

$$-\frac{\partial \mu \left(\sigma \vec{E}(\vec{x}, t) + \frac{\partial \epsilon \vec{E}(\vec{x}, t)}{\partial t} \right)}{\partial t} = \vec{\nabla} \left(\frac{1}{\epsilon} \rho(\vec{x}, t) \right) - \vec{\nabla}^2 \vec{E}(\vec{x}, t)$$

$$\vec{\nabla}^2 \vec{E}(\vec{x}, t) = \mu \sigma \frac{\partial \vec{E}(\vec{x}, t)}{\partial t} + \mu \epsilon \frac{\partial^2 \mu \epsilon \vec{E}(\vec{x}, t)}{\partial t^2} + \frac{1}{\epsilon} \vec{\nabla} \rho(\vec{x}, t)$$

For source-free regions, $\vec{\nabla} \rho(\vec{x}, t) = 0$.

$$\vec{\nabla}^2 \vec{E}(\vec{x}, t) = \mu \sigma \frac{\partial \vec{E}(\vec{x}, t)}{\partial t} + \mu \epsilon \frac{\partial^2 \mu \epsilon \vec{E}(\vec{x}, t)}{\partial t^2}$$

By expressing the above equation in time-harmonic form, $e^{j\omega t}$, and letting $\vec{E}(\vec{x}) = \vec{E}$ the time-harmonic electric field is then

$$\vec{\nabla}^2 \vec{E} = j\omega\mu\sigma\vec{E} - \omega^2\mu\epsilon\vec{E}$$

where

$$\gamma^2 = j\omega\mu\sigma - \omega^2\mu\epsilon$$

$$\gamma = \alpha + j\beta$$

From the above, γ is the propagation constant, α is the attenuation constant, and β is the phase constant.

From the IEEE Standard Definitions for Antennas, the polarization of a radiated wave is defined as “that property of radiated electromagnetic wave describing the time-varying direction and relative magnitude of the electric field vector; specifically, the figure traced as a function of time by the extremity vector at a fixed location in space, and the sense in which it is traced, as observed along the direction of propagation.” This means that polarization is the curve traced out, at a point of observation in space of the propagating electromagnetic wave as a function of time, by the end point of the arrow representing the instantaneous electric field. The observation point must be along the direction of propagation, see Figure 1-1.

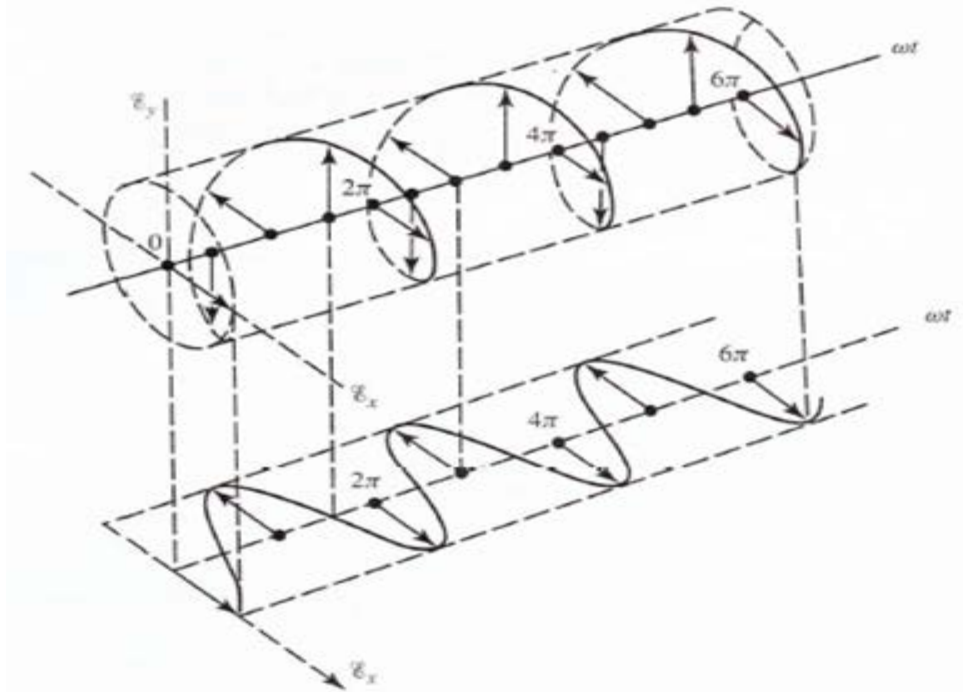

Figure 1.1 Polarized Electric Wave Along the Z Axis from Balanis [9]

Polarization can be classified into three categories: linear, circular, and elliptical, see Figure 1.2. If the vector that describes the electric field at a fixed point in space as a function of time is directed along a line that is normal to the direction of propagation then the field is said to be linearly polarized. However, linear and circular polarizations are special cases of elliptical polarization, and are obtained when the ellipse becomes a line or a circle. In general the trace of the electric field is an ellipse. The sense is considered as either right hand polarization (clockwise) or left hand polarization (counterclockwise).

A time-harmonic field is linearly polarized at a given point in space if the electric field vector at that point is oriented along the same line at every instant in time. There are two scenarios that make this possible, a field vector contains only a single

component, or if the field vector contains two orthogonal components that are linearly polarized, and in time phase or integer multiples of 180° out of phase. To illustrate this, consider the following. Let

$$\vec{E}_x = E_{x0}^+ \cos(\omega t - \beta z + \phi_x)$$

$$\vec{E}_y = 0$$

For simplicity, let the observation be at the plane $z = 0$. Then the locus of the instantaneous electric field vector is

$$\vec{E} = \vec{E}_x = E_{x0}^+ \cos(\omega t + \phi_x)$$

which is a straight line directed along the x-axis, see Figure 1.2

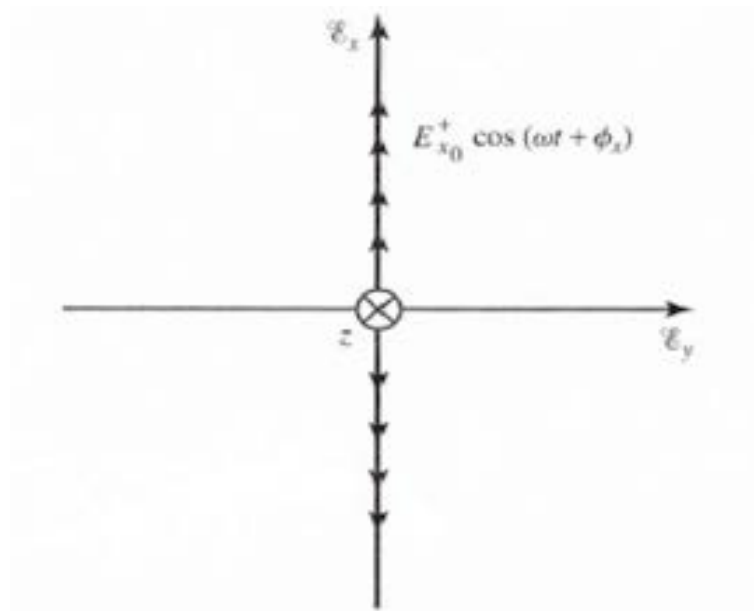

Figure 1.2 Linearly Polarized Plane Wave Along the X Axis from Balanis [9]

Consider also

$$\phi_x = \phi_y$$

$$\vec{E}_x = E_{x0}^+ \cos(\omega t + \phi_x)$$

$$\vec{E}_y = E_{y0}^+ \cos(\omega t + \phi_y)$$

$$|\vec{E}| = \sqrt{\vec{E}_x^2 + \vec{E}_y^2} = \sqrt{E_{x0}^{+2} + E_{y0}^{+2}} \cos(\omega t + \phi_x)$$

which is a straight line directed along the angle ψ from the positive x-axis given by

$$\psi = \tan^{-1} \left(\frac{\vec{E}_y}{\vec{E}_x} \right) = \tan^{-1} \left(\frac{E_{y0}^+}{E_{x0}^+} \right)$$

See Figure 1.3.

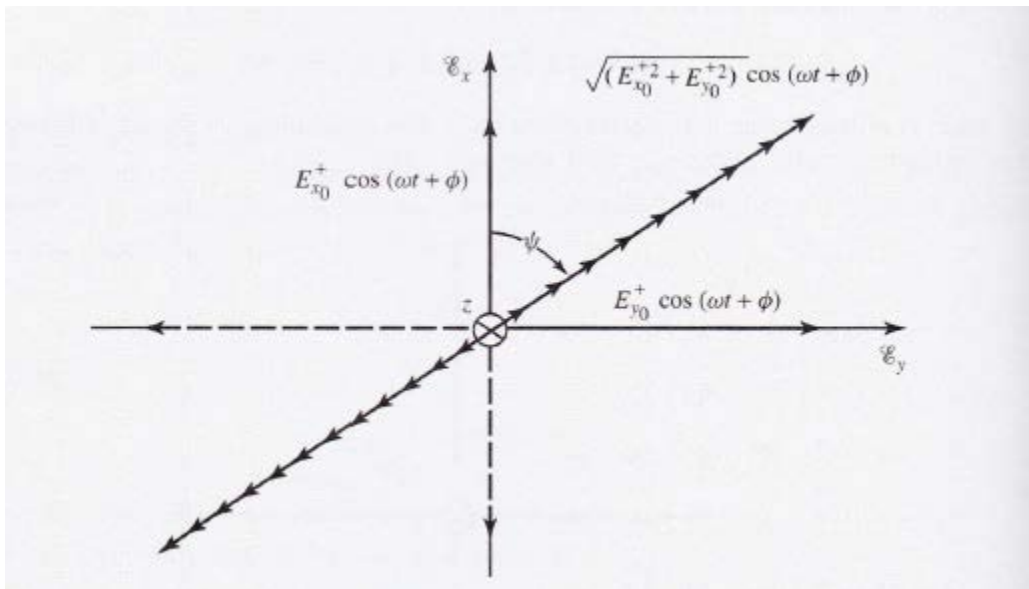

Figure 1.3 Linearly Polarized Field in the Direction of ψ from Balanis [9]

A wave is considered to be circularly polarized if the tip of the electric field vector traces out a circular locus in space. As previously discussed, the sense of rotation can be either right-hand (CW) or left-hand (CCW). For a circularly polarized wave the

following criteria must be met. The field must have two orthogonally linearly polarized components, the two components must be equal in magnitude, and the two components must have a time-phase difference of odd multiples of 90° . The following examples illustrate the process of determining the sense of rotation. Again consider observing the wave propagating in the positive z direction at the $z = 0$ plane.

$$\phi_x = 0$$

$$\phi_y = -\frac{\pi}{2}$$

$$E_{x0}^+ = E_{y0}^+ = E_R$$

$$\vec{E}_x = E_R \cos(\omega t)$$

$$\vec{E}_y = E_R \cos\left(\omega t - \frac{\pi}{2}\right) = E_R \sin(\omega t)$$

$$|\vec{E}| = \sqrt{E_R^2 (\cos^2 \omega t + \sin^2 \omega t)} = E_R$$

$$\psi = \tan^{-1}\left(\frac{E_R \sin(\omega t)}{E_R \cos(\omega t)}\right) = \tan^{-1}(\tan(\omega t)) = \omega t$$

The sense of rotation is determined by rotating the phase leading component (\vec{E}_x) towards the phase lagging component, which in this case is right-hand sense. See Figure 1.4.

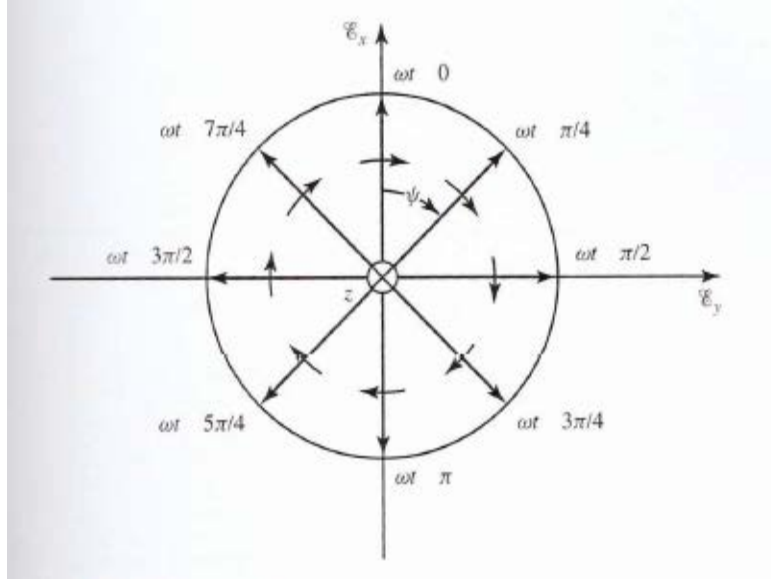

Figure 1.4 Right-Hand Circularly Polarized Wave from Balanis [9]

Similarly,

$$\phi_x = 0$$

$$\phi_y = \frac{\pi}{2}$$

$$E_{x0}^+ = E_{y0}^+ = E_R$$

$$\vec{E}_x = E_R \cos(\omega t)$$

$$\vec{E}_y = E_R \cos\left(\omega t + \frac{\pi}{2}\right) = -E_R \sin(\omega t)$$

$$|\vec{E}| = \sqrt{E_R^2 (\cos^2 \omega t + \sin^2 \omega t)} = E_R$$

$$\psi = \tan^{-1}\left(\frac{-E_R \sin(\omega t)}{E_R \cos(\omega t)}\right) = \tan^{-1}(\tan(\omega t)) = -\omega t$$

Again, the sense of rotation is determined by rotating the phase leading component (\vec{E}_y) to the phase lagging component, which in this case is left-hand sense. See Figure 1.5.

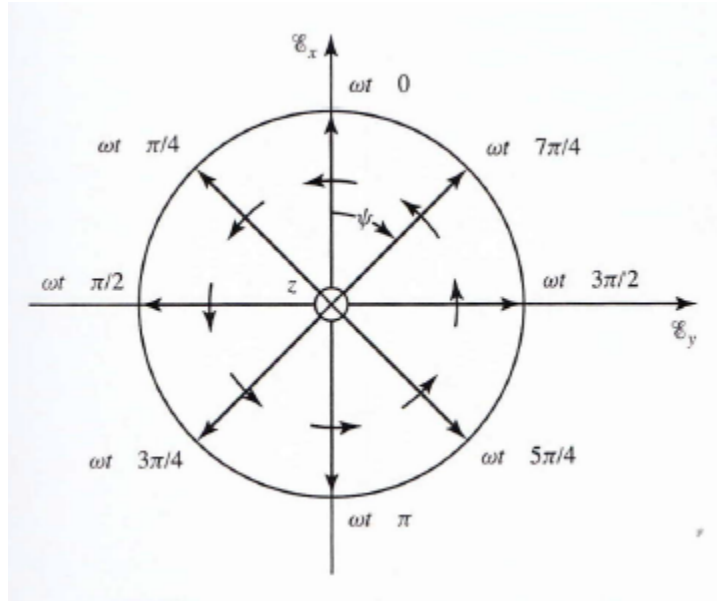

Figure 1.5 Left-Hand Circularly Polarized Wave from Balanis [9]

A wave is considered elliptically polarized if the tip of the electric field vector traces an ellipse in space as a function of time. Like circular polarization, it is right-hand elliptically polarized if the electric field vector of the ellipse rotates clockwise, or a left-hand elliptically polarized if it rotates counter-clockwise. Consider the following,

$$\phi_x = \frac{\pi}{2}$$

$$\phi_y = 0$$

$$E_{x0}^+ = (E_R + E_L)$$

$$E_{y0}^+ = (E_R - E_L)$$

$$\vec{E}_x = (E_R + E_L) \cos\left(\omega t + \frac{\pi}{2}\right) = -(E_R + E_L) \sin(\omega t)$$

$$\vec{E}_y = (E_R - E_L) \cos(\omega t)$$

$$\begin{aligned} \vec{E}^2 &= \vec{E}_x^2 + \vec{E}_y^2 = (E_R + E_L)^2 \sin^2(\omega t) + (E_R - E_L)^2 \cos^2(\omega t) \\ &= E_R^2 + E_L^2 + 2E_R E_L [\sin^2(\omega t) - \cos^2(\omega t)] \end{aligned}$$

$$\sin(\omega t) = \frac{-\vec{E}_x}{(E_R + E_L)}$$

$$\cos(\omega t) = \frac{\vec{E}_y}{(E_R - E_L)}$$

$$\left\{ \frac{\vec{E}_x}{(E_R + E_L)} \right\}^2 + \left\{ \frac{\vec{E}_y}{(E_R - E_L)} \right\}^2 = 1$$

which is the equation of an ellipse with major axis $|E_{max}| = |E_R + E_L|$ and minor axis

$|E_{min}| = |E_R - E_L|$.

$$|\vec{E}_{max}| = |E_R + E_L|, \text{ when } \omega t = (2n + 1) \frac{\pi}{2}, n = 0, 1, 2, \dots$$

$$|\vec{E}_{min}| = |E_R - E_L|, \text{ when } \omega t = n\pi, n = 0, 1, 2, \dots$$

The axial ratio is the ratio of the major axis to the minor axis of the polarization ellipse.

$$AR = -\frac{\vec{E}_{max}}{\vec{E}_{min}} = -\frac{2(E_R + E_L)}{2(E_R - E_L)} = -\frac{(E_R + E_L)}{(E_R - E_L)}$$

Both E_R and E_L are positive real quantities. The axial ratio, AR , can be positive, left-hand polarization, or negative, right-hand polarization with the range $1 \leq |AR| \leq \infty$.

The instantaneous electric field vector can be written as,

$$\vec{E} = Re \left\{ \hat{a}_x [E_R + E_L] e^{j(\omega t - \beta z + \frac{\pi}{2})} + \hat{a}_y [E_R - E_L] e^{j(\omega t - \beta z)} \right\}$$

$$\vec{E} = Re \left\{ [\hat{a}_x j(E_R + E_L) + \hat{a}_y (E_R - E_L)] e^{j(\omega t - \beta z)} \right\}$$

$$\vec{E} = Re \left\{ [E_R (j\hat{a}_x + \hat{a}_y) + E_L (j\hat{a}_x - \hat{a}_y)] e^{j(\omega t - \beta z)} \right\}$$

It is evident here that the elliptical wave is the sum of a right-hand and a left hand circularly polarized wave represented by the first term and second term, respectively. If $E_R > E_L$ then the axial ratio will be negative and the right-hand circular component will dominate the left-hand circular component. The electric vector will then rotate in the same direction as a right-hand circularly polarized wave, and will be considered a right-hand elliptically polarized wave. If $E_L > E_R$ then the axial ratio will be positive and the left-hand circular component will dominate the right-hand circular component. The electric vector will then rotate in the same direction as a left-hand circularly polarized wave, and will be considered a left-hand elliptically polarized wave. See Figure 1.6.

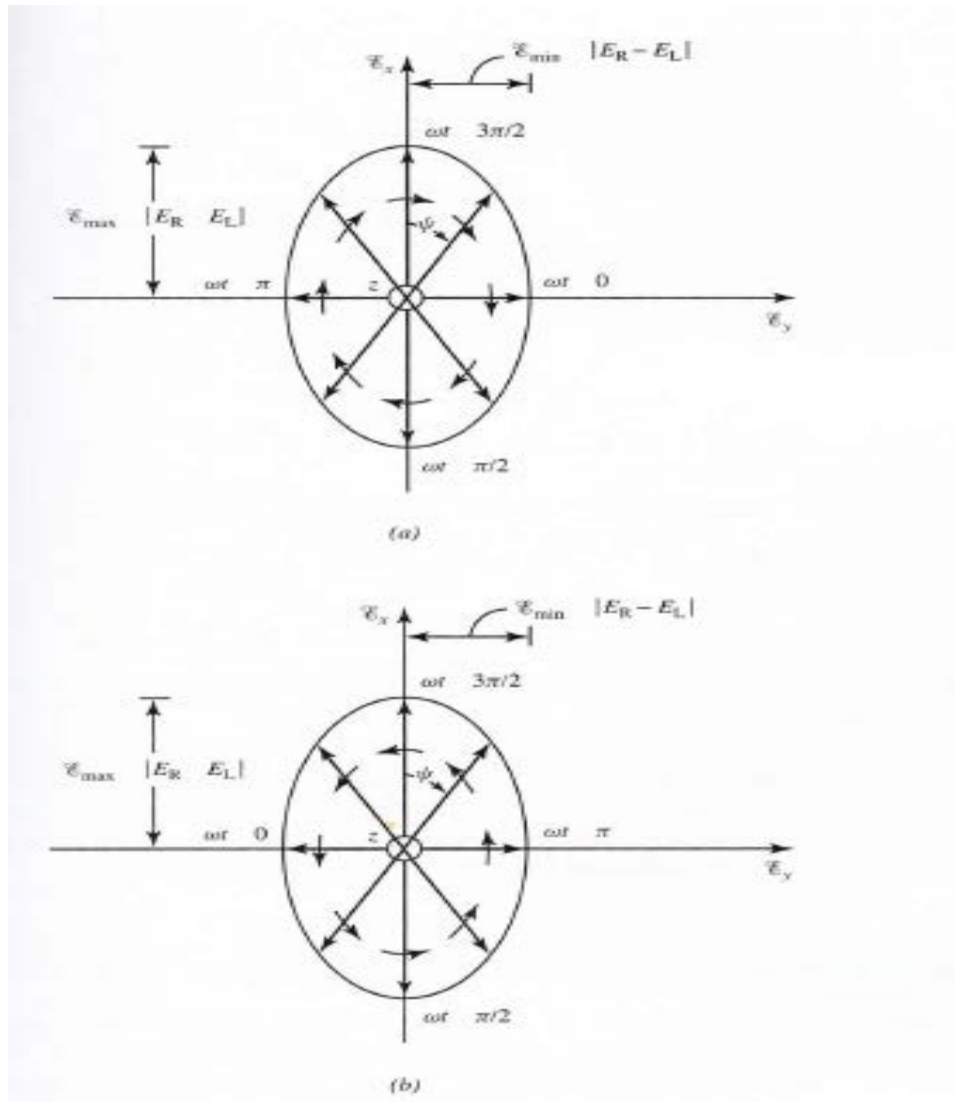

Figure 1.6 Right and Left-Hand Elliptically Polarized Waves With Major Axis Along x Axis from Balanis [9]

A more general case can be considered when the polarized locus is that of a tilted ellipse in Figure 1.7, which represents the fields when

$$\Delta\phi = \phi_x - \phi_y \neq \frac{n\pi}{2} \quad n = 0, 2, 4, \dots$$

$$\geq 0 \begin{cases} \text{for CW if } E_R > E_L \\ \text{for CCW if } E_L > E_R \end{cases}$$

$$\leq 0 \begin{cases} \text{for CW if } E_R < E_L \\ \text{for CCW if } E_L < E_R \end{cases}$$

$$E_{x0}^+ = (E_R + E_L)$$

$$E_{y0}^+ = (E_R - E_L)$$

The axial ratio is equal to

$$AR = \pm \frac{\text{major axis}}{\text{minor axis}} = \pm \frac{OA}{OB}, \quad 1 \leq |AR| \leq \infty$$

where

$$OA = \left[\frac{1}{2} \left\{ (E_{x0}^+)^2 + (E_{y0}^+)^2 + \left[(E_{x0}^+)^4 + (E_{y0}^+)^4 + 2(E_{x0}^+)^2(E_{y0}^+)^2 \cos(2\Delta\phi) \right]^{1/2} \right\} \right]^{1/2}$$

$$OB = \left[\frac{1}{2} \left\{ (E_{x0}^+)^2 + (E_{y0}^+)^2 - \left[(E_{x0}^+)^4 + (E_{y0}^+)^4 + 2(E_{x0}^+)^2(E_{y0}^+)^2 \cos(2\Delta\phi) \right]^{1/2} \right\} \right]^{1/2}$$

Note that in the equations above that the “+” sign is for left-hand polarization, and that the “-” sign is for right-hand polarization.

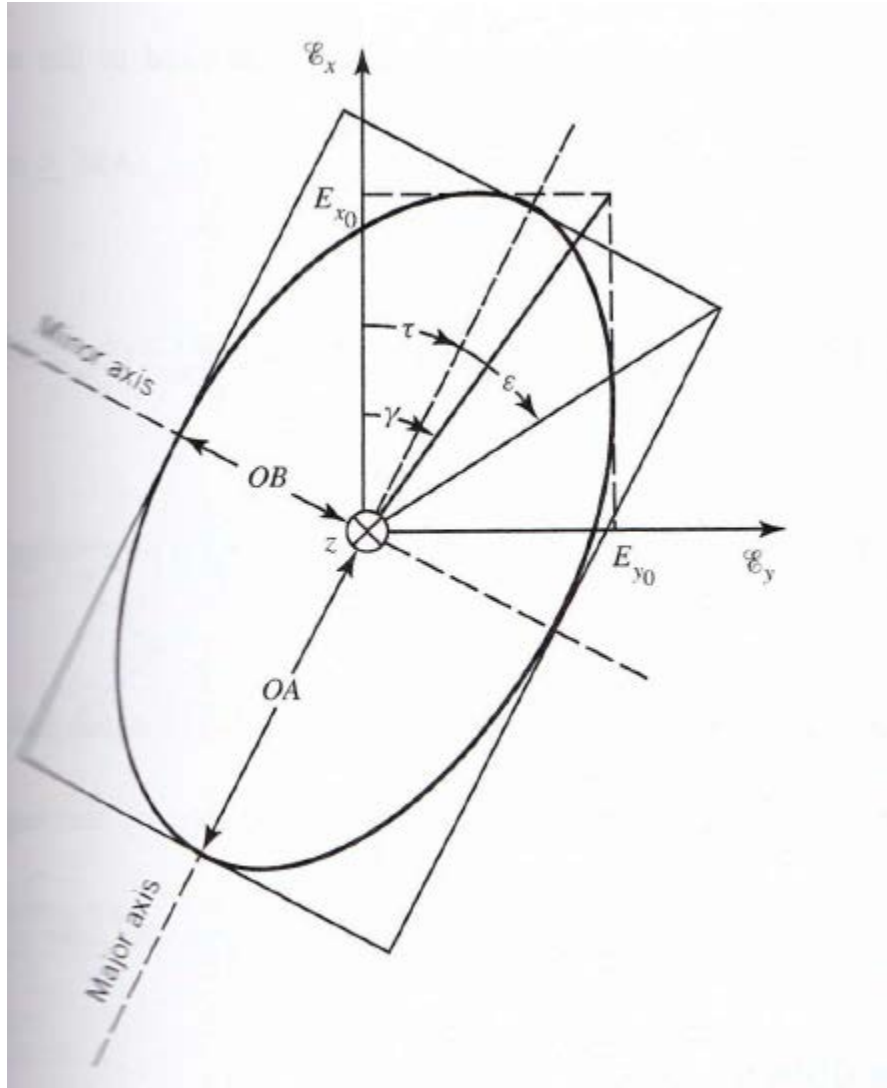

Figure 1.7 Rotated Electromagnetic Plane Wave and It's Tilted Ellipse from Balanis [9]

The Poincare sphere is shown in Figure 1.8, along with the polarization state. The polarization state can be uniquely represented by a point on the surface of the Poincare sphere. This is done with either of the two pairs of angles (γ, δ) or (ϵ, τ) . The two pairs of angles are defined as below

(γ, δ) set:

$$\gamma = \tan^{-1} \left(\frac{E_{y0}^+}{E_{x0}^+} \right) \text{ or } \gamma = \tan^{-1} \left(\frac{E_{x0}^+}{E_{y0}^+} \right), 0 \leq \gamma \leq 90^\circ$$

$$\partial = \phi_y - \phi_x - 180^\circ \leq \partial \leq 180^\circ$$

where ∂ is the phase difference between \vec{E}_x and \vec{E}_y .

(ε, τ) set:

$$\varepsilon = \cot^{-1}(AR) - 45^\circ \leq \varepsilon \leq +45^\circ$$

$$\tau = \text{tilt angle } 0^\circ \leq \tau \leq 180^\circ$$

where

$$2\varepsilon = \text{latitude}$$

$$2\tau = \text{longitude}$$

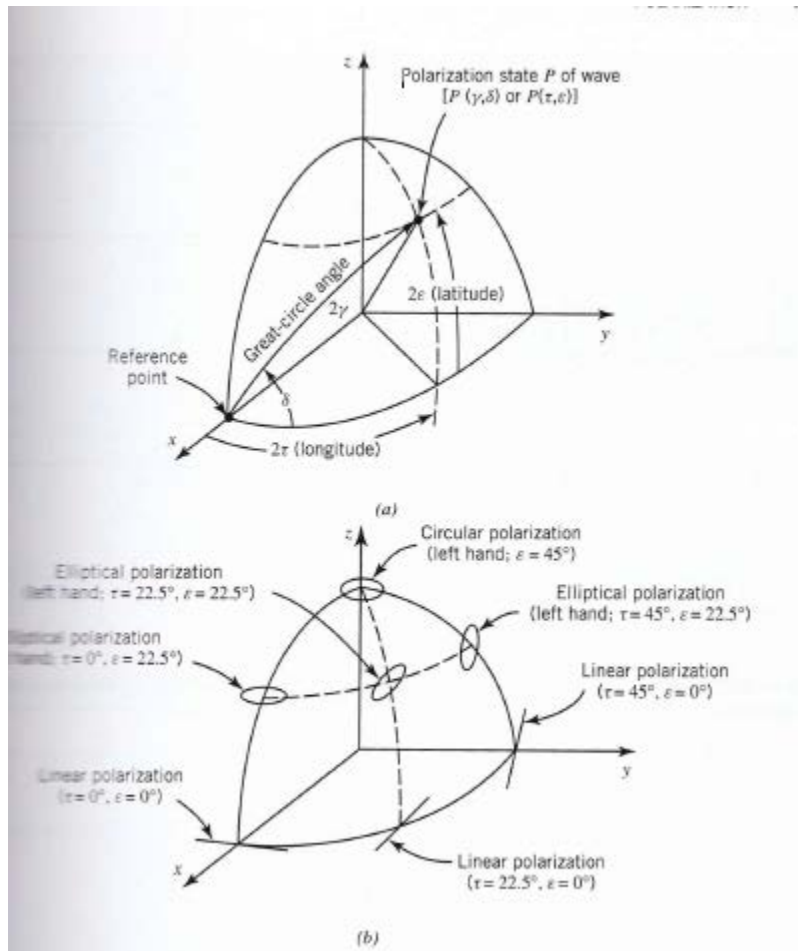

Figure 1.8 Poincare Sphere For the Polarization State of the Wave from Balanis [9]

The axial ratio is positive for left-hand polarization and negative for right-hand polarization. The Poincare sphere in Figure 1.8 represents the polarization states on the first octant. The planar surface representations of the Poincare sphere are also shown in Figure 1-9. The angles (γ, δ) and (ϵ, τ) are related by

$$\cos(2\gamma) = \cos(2\epsilon) \cos(2\tau)$$

$$\tan(\delta) = \frac{\tan(2\epsilon)}{\sin(2\tau)}$$

or

$$\sin(2\varepsilon) = \sin(2\gamma) \sin(\vartheta)$$

$$\tan(2\tau) = \tan(2\gamma) \cos(\vartheta)$$

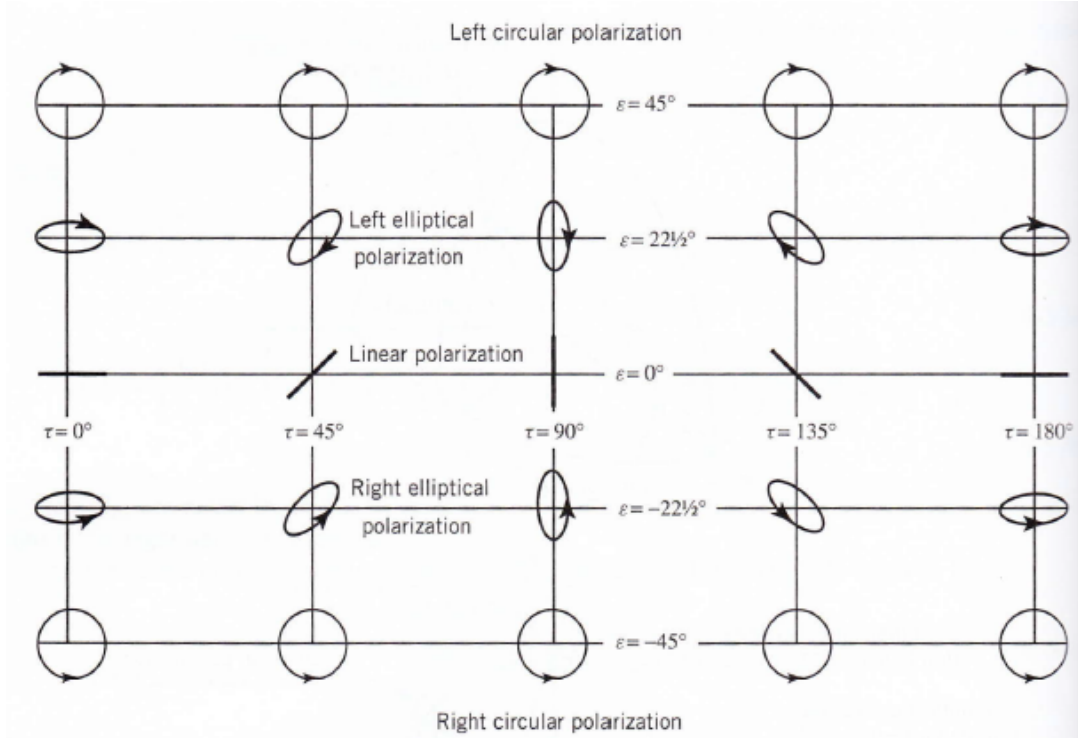

Figure 1.9 Polarization States of a Wave on a Planar Surface Projection from Balanis [9]

It is clear that the linear polarization is found along the equator; the right-hand circular is located along the south pole and the left-hand circular is along the north pole. The remaining surface of the sphere represents elliptical polarization with left-hand elliptical in the upper hemisphere, and right-hand elliptical in the lower hemisphere.

Chapter 2

Huynen Scattering Matrix Decomposition

Cameron Decomposition utilizes principles and notations presented by Huynen[2]. Huynen's Phenomenological Decomposition will be presented here, as well as the parameters and concepts that are fundamental in Cameron Decomposition [1]. This chapter will also build upon the concepts presented in the previous chapter, regarding propagation and polarization, to relate to some important concepts in the theory of radar targets.

Radar targets are represented by "patterns" that are plots of the RCS versus angle of observation at a given radar frequency and polarization of transmitter and receiver. The direction of line of sight from the antenna to the target is known as the aspect direction. The coordinate frame of the target is aligned with the target's axis direction. Referencing the target's coordinate frame, the aspect direction is expressed in terms of roll angle and pattern angle. The target aspect direction is important for target scattering because it exposes different parts of the target's surface. It should be noted that most "static" RCS patterns are a function of the pattern angle for fixed roll positions. The aforementioned measurements are obtained by radar range measurements. The orientation angle, ψ_a , is a geometric motion parameter only, which

orients the target in space with reference to a fixed ground station for a fixed target exposure. In general, the target's scattering is dependent on the orientation angle since it changes the orientation of polarization of the illumination. Figure 2.1 shows a depiction of aspect direction and orientation angle. From the point of view of the observer, the target axis of orientation is a variable of the targets motion and has no affect on the target exposure. Hence, the axis orientation has no affect on the scattering matrix, which is associated with target exposure.

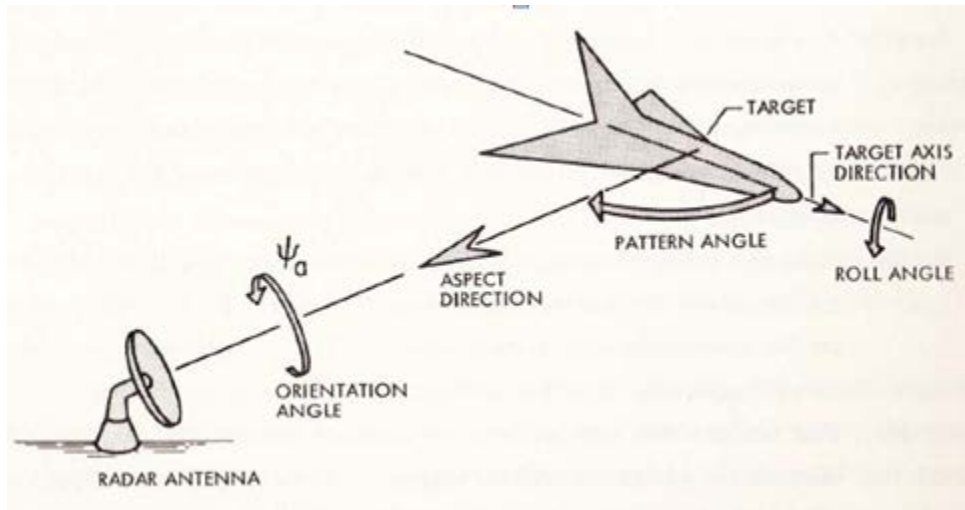

Figure 2.1 Target Aspect Direction and Orientation Angle from Huynen [2]

From the material presented above Huynen [2] makes several key points to help avoid misconceptions regarding radar signature analysis. To begin, the target exposure determines the target's backscatter properties and its scattering matrix. A change in the target axis orientation, ψ_a , with exposure fixed can be accounted for by a corresponding coordinate transformation of the scattering matrix. The coordinate transformation is

due to an effective change of orientation of polarization of target illumination. Although the scattering is thus affected by changes in target orientation, since the scattering is determined by the scattering matrix, the effect of orientation angle on the scattering can be accounted for if the orientation angle is known from the target's position relative to the radar observation point. For studies that aim to link radar target scattering properties to basic body geometry and structure, it is essential to subtract the effect of the orientation angle on the target scattering. This procedure leads to orientation invariant target parameters. The aforementioned procedure can be carried out successfully only if the scattering matrix of the target is known from observations. Hence, most radars that observe targets with a single polarization produce target signatures that are obscured by the orientation angle parameter. It is unlikely that these target signatures obtained with single polarization radars can be shown to have significant correlations with target geometry and structure. A significant exception to the later discussion is the use of radars that have a single circular polarization. Since the circular polarization illumination itself is unbiased to target orientation, the target amplitude return signature in this case will also be orientation invariant. The process of eliminating the effect of orientation angle on the scattering matrix, and hence on target signature, does not require knowledge of the orientation itself; only the scattering matrix has to be known from radar measurements.

It should be noted here that the elliptically polarized electric wave is analyzed in a slightly different manner than presented earlier from Balanis [9]. From Figure 2.2 the y-plane is represented by the vertical axis, and the x-plane is represented by the

horizontal. Furthermore the angle ϕ is used to denote the angle of orientation from the x-axis to the major axis of the ellipse, and τ denotes the angle from the major axis to the line connecting the major axis to the minor axis. The range of the ellipticity angle is $-45^\circ \leq \tau \leq 45^\circ$. For linear polarization $\tau = 0^\circ$, and for circular polarization $\tau = \pm 45^\circ$. As defined in Balanis [9], the point of observation is that in which the wave is propagating away from the point of observation.

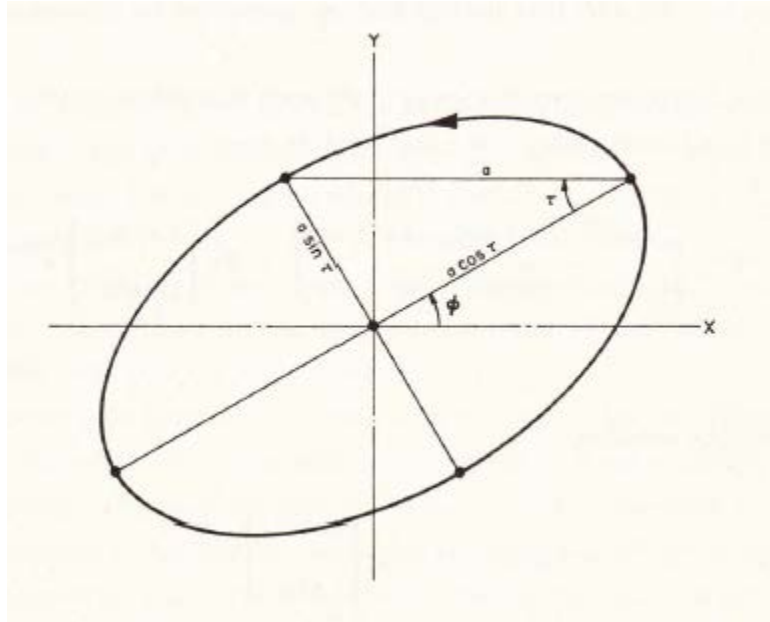

Figure 2.2 Left Sensed Polarization Ellipse from Huynen [2]

Huynen [2] describes the electric plane wave propagating transverse along the z-axis with two components E_x and E_y along the horizontal and vertical axis, respectively.

$$\vec{E} = \begin{bmatrix} E_x \\ E_y \end{bmatrix} = \begin{bmatrix} a_x \cos(\omega t - kz + \alpha_x) \\ a_y \sin(\omega t - kz + \alpha_y) \end{bmatrix}$$

where, a_x and a_y are the component magnitudes, $k = \frac{2\pi f}{c}$ (c is the propagation velocity in free space), and α_x and α_y are the respective phases. The real part is then written as

$$\vec{E} = \text{Re} \begin{bmatrix} a_x e^{i\alpha_x} \\ a_y e^{i\alpha_y} \end{bmatrix} e^{i(\omega t - kz)}$$

It is common practice to drop the exponential propagation factor and the “Re”, when dealing with time harmonic problems. The plane wave is then determined by two complex valued components,

$$\vec{E} = \begin{bmatrix} E_x \\ E_y \end{bmatrix} = \begin{bmatrix} a_x e^{i\alpha_x} \\ a_y e^{i\alpha_y} \end{bmatrix}$$

In the equation above it is considered that the wave is produced by a transmit antenna, and that the same expression characterizes the transmit antenna.

$$\vec{a} = \begin{bmatrix} a_x e^{i\alpha_x} \\ a_y e^{i\alpha_y} \end{bmatrix} = \begin{bmatrix} \sqrt{g_x} \\ \sqrt{g_y} e^{i\partial_\alpha} \end{bmatrix} e^{i\alpha_x}$$

Where, $g_x = a_x^2$ and $g_y = a_y^2$ are the antenna gain functions in the x and y-channels. The total antenna gain, $g_0 = g_x + g_y$, is a measure of the antenna radiation efficiency in a given direction. The variable ∂_α is the difference in phases between the x and y-channels. An antenna may also be used as a radar receiver and will have the same gain and phase characteristics that it would if it were a transmit antenna.

Since antenna gain functions are tied to the fixed (x, y, z) coordinate frame, and targets are independent of this frame the gain functions are thus inconvenient to use.

Geometric variables of the elliptically polarized wave are best suited to describe the elliptically polarized wave that the antenna produces.

In chapter 1, the general form of an elliptically polarized electric wave was described. Using those concepts and Huynen's [2] parameters above the elliptically polarized plane wave can be written as

$$\vec{a}(a, \alpha, \phi, \tau) = a \begin{bmatrix} \cos \phi & -\sin \phi \\ \sin \phi & \cos \phi \end{bmatrix} \begin{bmatrix} \cos \tau \\ i \sin \tau \end{bmatrix} e^{i\alpha}$$

where, a is the magnitude, α is the absolute phase, ϕ is the orientation angle, and τ is the ellipticity angle. The absolute phase (also known as the nuisance phase) determines the phase reference of the antenna at time $t = 0$, and for most practical applications may be ignored. It is possible to determine the set (a, α, ϕ, τ) from the set $(a_x, a_y, \alpha_x, \alpha_y)$ and vice versa.

The following is a summarization of some matrix algebraic properties that are helpful in simplifying calculations with polarization vectors that would otherwise be tedious. Beginning with the general elliptically polarized antenna equation,

$$\vec{a}(a, \alpha, \phi, \tau) = a \begin{bmatrix} \cos \phi & -\sin \phi \\ \sin \phi & \cos \phi \end{bmatrix} \begin{bmatrix} \cos \tau \\ i \sin \tau \end{bmatrix} e^{i\alpha} = e^{\phi J} \vec{a}(a, \alpha, \tau)$$

$$e^{\phi J} = \begin{bmatrix} \cos \phi & -\sin \phi \\ \sin \phi & \cos \phi \end{bmatrix} = \cos \phi \begin{bmatrix} 1 & 0 \\ 0 & 1 \end{bmatrix} + \sin \phi \begin{bmatrix} 0 & -1 \\ 1 & 0 \end{bmatrix}$$

or

$$e^{\phi J} = \cos \phi I + \sin \phi J$$

where $I = \begin{bmatrix} 1 & 0 \\ 0 & 1 \end{bmatrix}$ is the unit matrix, and $J = \begin{bmatrix} 0 & -1 \\ 1 & 0 \end{bmatrix}$ is the 90° spatial rotation matrix

for which $J^2 = -I$.

$$J^2 = \begin{bmatrix} 0 & -1 \\ 1 & 0 \end{bmatrix} \begin{bmatrix} 0 & -1 \\ 1 & 0 \end{bmatrix} = \begin{bmatrix} (0 \times 0) + (-1 \times 1) & (0 \times -1) + (-1 \times 0) \\ (1 \times 0) + (0 \times 1) & (1 \times -1) + (0 \times 0) \end{bmatrix} = \begin{bmatrix} -1 & 0 \\ 0 & -1 \end{bmatrix}$$

hence

$$J^2 = -I$$

From these properties it can be verified that

$$e^{\phi J} = \sum_{n=0}^{\infty} \frac{\phi^n}{n!} J^n = \cos \phi I + \sin \phi J$$

The component $\vec{a}(\tau)$ can be written as

$$\vec{a}(\tau) = \begin{bmatrix} \cos \tau \\ i \sin \tau \end{bmatrix} = \begin{bmatrix} \cos \tau & i \sin \tau \\ i \sin \tau & \cos \tau \end{bmatrix} \begin{bmatrix} 1 \\ 0 \end{bmatrix} = e^{\tau K} \begin{bmatrix} 1 \\ 0 \end{bmatrix}$$

where

$$e^{\tau K} = \cos \tau I + \sin \tau K$$

$$K = \begin{bmatrix} 0 & i \\ i & 0 \end{bmatrix}$$

$$K^2 = \begin{bmatrix} 0 & i \\ i & 0 \end{bmatrix} \begin{bmatrix} 0 & i \\ i & 0 \end{bmatrix} = \begin{bmatrix} -1 & 0 \\ 0 & -1 \end{bmatrix} = -I$$

Also,

$$L = JK = -KJ = \begin{bmatrix} -i & 0 \\ 0 & i \end{bmatrix}$$

$$L^2 = \begin{bmatrix} -i & 0 \\ 0 & i \end{bmatrix} \begin{bmatrix} -i & 0 \\ 0 & i \end{bmatrix} = \begin{bmatrix} -1 & 0 \\ 0 & -1 \end{bmatrix} = -I$$

$$e^{vL} = \cos v I + \sin v L = \begin{bmatrix} e^{-iv} & 0 \\ 0 & e^{iv} \end{bmatrix}$$

Matrices I, J, K, and L are representations of the quaternion group with the multiplication table shown in Figure 2.3.

	I	J	K	L
I	I	J	K	L
J	J	-I	L	-K
K	K	-L	-I	J
L	L	K	-J	-I

Figure 2.3 Quaternion Multiplication Table from Huynen [2]

Let J stand for J, K, or L then a useful equation can be written

$$e^{(\alpha+\beta)J} = e^{\alpha J} \cdot e^{\beta J} = e^{\beta J} \cdot e^{\alpha J}$$

which follows from commutative rule. Another rule follows

$$K e^{\alpha J} = K(\cos \alpha I + \sin \alpha J) = (\cos \alpha I - \sin \alpha J)K = e^{-\alpha J} K$$

If K were to be replaced by two non-identical members of (J,K,L) then similar relationships exists. From these rules it can be shown that

$$e^{\alpha J} e^{\beta K} \neq e^{\beta K} e^{\alpha J}$$

and that

$$e^{\alpha J} e^{\beta K} = e^{\alpha J} (\cos \beta I + \sin \beta K) = e^{\alpha J} \cos \beta + \sin \beta K e^{-\alpha J}$$

$$e^{\alpha J} e^{\beta K} = e^{\alpha J} \cos \beta + \sin \beta K \cos \alpha + \sin \beta \sin \alpha L$$

$$e^{\beta K} e^{\alpha J} = (\cos \beta I + \sin \beta K) e^{\alpha J} = e^{\alpha J} \cos \beta + \sin \beta K e^{\alpha J}$$

$$e^{\beta K} e^{\alpha J} = e^{\alpha J} \cos \beta + \sin \beta K - \sin \beta \sin \alpha L$$

$$e^{\alpha J} e^{\beta K} - e^{\beta K} e^{\alpha J} = 2 \sin \beta \sin \alpha L$$

Matrices of the following form are often computed,

$$\begin{aligned} e^{\alpha_1 J} e^{\beta K} e^{\alpha_2 J} &= e^{\alpha_1 J} (\cos \beta I + \sin \beta K) e^{\alpha_2 J} = \cos \beta e^{(\alpha_1 + \alpha_2) J} + \sin \beta K e^{(\alpha_2 - \alpha_1) J} \\ &= \cos \beta \cos(\alpha_1 + \alpha_2) I + \cos \beta \sin(\alpha_1 + \alpha_2) J + \sin \beta \cos(\alpha_1 - \alpha_2) K \\ &\quad + \sin \beta \sin(\alpha_1 - \alpha_2) L \end{aligned}$$

The matrix algebra rules make it much easier to express sum and difference angles than it would be to compute using matrix multiplication and trigonometric identities. The expression of an elliptically polarized antenna can now be written as,

$$\vec{a}(a, \alpha, \phi, \tau) = a e^{i\alpha} e^{\phi J} e^{\tau K} \begin{bmatrix} 1 \\ 0 \end{bmatrix}$$

and is in the form of exponential matrices with geometric parameters a , α , ϕ , and τ .

The dot product is used to determine the received voltage at the receiver terminals. Given the two polarization vectors \vec{a} and \vec{b} ,

$$\vec{a} \cdot \vec{b} = a_x e^{i\alpha_x} b_x e^{i\beta_x} + a_y e^{i\alpha_y} b_y e^{i\beta_y} = \vec{b}' \cdot \vec{a} = a' b = b a$$

where “ ' ” indicates the transposed vector and the last two forms are matrix multiplications. If A is a 2x2 matrix which transforms \vec{a} to $(A\vec{a})$ then by using the above definition,

$$(A\vec{a}) \cdot \vec{b} = (A\vec{a})' \cdot \vec{b} = \vec{a}' A' \vec{b} = \vec{a}' \cdot A' \vec{b}$$

where A' is the transposed matrix A, obtained by reflections of A about the main diagonal. Applying this to the expression of an elliptically polarized antenna it is shown that

$$\begin{aligned} \vec{a} \cdot \vec{a}^* &= a e^{i\alpha} e^{\phi J} e^{\tau K} \begin{bmatrix} 1 \\ 0 \end{bmatrix} \cdot a e^{-i\alpha} e^{\phi J} e^{-\tau K} \begin{bmatrix} 1 \\ 0 \end{bmatrix} = a^2 e^{-\phi J} e^{\phi J} e^{\tau K} \begin{bmatrix} 1 \\ 0 \end{bmatrix} \cdot e^{-\tau K} \begin{bmatrix} 1 \\ 0 \end{bmatrix} \\ &= a^2 e^{\tau K} \begin{bmatrix} 1 \\ 0 \end{bmatrix} \cdot e^{-\tau K} \begin{bmatrix} 1 \\ 0 \end{bmatrix} = a^2 \end{aligned}$$

and

$$\vec{a} \cdot \vec{a}^* = g_x + g_y = g_0$$

$$g_0 = a^2$$

is the total antenna gain.

If $\vec{a} = \vec{a}(\theta, \tau)$ then it can be shown that for orthogonal polarization, $\vec{a}_\perp = \vec{a}(\theta + \frac{\pi}{2}, -\tau)$. In the case of elliptically polarized antenna

$$\vec{a}_\perp = ae^{i\alpha_\perp} e^{(\phi+\frac{\pi}{2})J} e^{-\tau K} \begin{bmatrix} 1 \\ 0 \end{bmatrix}$$

$$\begin{aligned} \vec{a} \cdot \vec{a}_\perp^* &= ae^{i\alpha} e^{\phi J} e^{\tau K} \begin{bmatrix} 1 \\ 0 \end{bmatrix} \cdot ae^{-i\alpha_\perp} e^{(\phi+\frac{\pi}{2})J} e^{\tau K} \begin{bmatrix} 1 \\ 0 \end{bmatrix} = aa_\perp e^{i(\alpha-\alpha_\perp)} e^{-\frac{\pi}{2}J} e^{\tau K} \begin{bmatrix} 1 \\ 0 \end{bmatrix} \cdot e^{\tau K} \begin{bmatrix} 1 \\ 0 \end{bmatrix} \\ &= -aa_\perp e^{i(\alpha-\alpha_\perp)} e^{\tau K} J e^{\tau K} \begin{bmatrix} 1 \\ 0 \end{bmatrix} \cdot \begin{bmatrix} 1 \\ 0 \end{bmatrix} = -aa_\perp e^{i(\alpha-\alpha_\perp)} J e^{-\tau K} e^{\tau K} \begin{bmatrix} 1 \\ 0 \end{bmatrix} \cdot \begin{bmatrix} 1 \\ 0 \end{bmatrix} \\ &= 0 \end{aligned}$$

Huynen [2] also describes other special polarizations, but the one of particular interest for Cameron decomposition is the symmetric polarization, $\vec{a}_s = \vec{a}(a, \alpha, -\phi, -\tau)$, and the following relationship for the derivation of reciprocity.

$$iL\vec{a} = iae^{i\alpha} Le^{\phi J} e^{\tau K} \begin{bmatrix} 1 \\ 0 \end{bmatrix} = iae^{i\alpha} e^{-\phi J} e^{-\tau K} \begin{bmatrix} -i \\ 0 \end{bmatrix} = \vec{a}_s(\phi, \tau)$$

It is desired to determine the polarization properties of a radar transmit antenna by means of a set of receiver antenna polarizations. Let $\vec{a}(\phi_A, \tau_A)$ represent the polarization of a transmit antenna, and $\vec{E}_A(\phi_A, \tau_A)$ represent the transmitted elliptically polarized wave. Next, let $\vec{b}(\phi_B, \tau_B)$ represent the radar receiver antenna polarization that will be placed in the path of \vec{E}_A in the far field of antenna \vec{a} . It should be noted that for receiver, or transverse polarization, $\vec{a}_R = \vec{a}(a, -\alpha, -\phi, \tau)$. Calculating the received voltage at the \vec{b} terminals

$$V = \vec{E}_A(\phi_A, \tau_A) \cdot \vec{b}_R^*(\phi_B, \tau_B) = \vec{a} \cdot \vec{b}_R^*$$

which is of linear form, and

$$\vec{b}_R^*(\phi_B, \tau_B) = \vec{b}^*(-\phi_B, \tau_B) = \vec{b}(-\phi_B, -\tau_B) = \vec{b}_s$$

$$V = \vec{a} \cdot \vec{b}_R^* = \vec{a} \cdot \vec{b}_s = \vec{a} \cdot iL\vec{b} = iL\vec{a} \cdot \vec{b} = \vec{a}_s \cdot \vec{b} = \vec{a}_R^* \cdot \vec{b} = \vec{b} \cdot \vec{a}_R^*$$

proves that reciprocity is satisfied. Evaluating the above,

$$V = ae^{i\alpha} e^{\phi_A J} e^{\tau_A K} \begin{bmatrix} 1 \\ 0 \end{bmatrix} \cdot be^{i\beta} e^{-\phi_B J} e^{-\tau_B K} \begin{bmatrix} 1 \\ 0 \end{bmatrix} = abe^{i(\alpha+\beta)} e^{-\tau_B K} e^{(\phi_A+\phi_B)J} e^{\tau_A K} \begin{bmatrix} 1 \\ 0 \end{bmatrix} \cdot \begin{bmatrix} 1 \\ 0 \end{bmatrix}$$

$$= abe^{i(\alpha+\beta)} e^{-\tau_B K} [\cos(\phi_A + \phi_B) I + \sin(\phi_A + \phi_B) J] e^{\tau_A K} \begin{bmatrix} 1 \\ 0 \end{bmatrix} \cdot \begin{bmatrix} 1 \\ 0 \end{bmatrix}$$

$$V = abe^{i(\alpha+\beta)} [\cos(\phi_A + \phi_B) e^{(\tau_A - \tau_B)K} + J \sin(\phi_A + \phi_B) e^{(\tau_A + \tau_B)K}] \begin{bmatrix} 1 \\ 0 \end{bmatrix} \cdot \begin{bmatrix} 1 \\ 0 \end{bmatrix}$$

$$V = abe^{i(\alpha+\beta)} [\cos(\phi_A + \phi_B) (\cos(\tau_A - \tau_B) I + \sin(\tau_A - \tau_B) K)$$

$$+ \sin(\phi_A + \phi_B) J (\cos(\tau_A + \tau_B) I + \sin(\tau_A + \tau_B) K)] \begin{bmatrix} 1 \\ 0 \end{bmatrix} \cdot \begin{bmatrix} 1 \\ 0 \end{bmatrix}$$

$$V = abe^{i(\alpha+\beta)} [\cos(\phi_A + \phi_B) \cos(\tau_A - \tau_B) + i \sin(\phi_A + \phi_B) \sin(\tau_A + \tau_B)]$$

The power then received at antenna \vec{b} is then

$$P(\phi_B, \tau_B) = |V|^2$$

$$P(\phi_B, \tau_B) = \frac{a^2 b^2}{2} [1 + \sin(2\tau_A) \sin(2\tau_B) + \cos 2(\phi_A + \phi_B) \cos(2\tau_A) \cos(2\tau_B)]$$

The above equation shows that the parameters of antenna \vec{a} are measured directly by the set of polarizations of the receiver antenna \vec{b} . An expansion of the $\cos 2(\phi_A + \phi_B)$ term gives a linear expansion of the received power. A set of independent measurements of \vec{b} will provide a solution to the \vec{a} parameters. A typical set chosen for receiver polarizations are power measurements with horizontal ($\phi_B = 0, \tau_B = 0$),

vertical ($\phi_B = 90^\circ$, $\tau_B = 0$), 45° linear ($\phi_B = 45^\circ$, $\tau_B = 0$), and right-circular ($\tau_B = 45^\circ$).

The equation for the power received at the receiver antenna can be written in the following form

$$P = \frac{1}{2}(g_0 h_0 + g_1 h_1 + g_2 h_2 - g_3 h_3)$$

where g annotates the parameters of \vec{a} and h annotates the parameters of \vec{b} . The Stokes parameters of the elliptically polarized antenna $\vec{a}(a, \phi, \tau)$ are defined as

$$g_0 = a^2$$

$$g_1 = a^2 \sin 2\tau$$

$$g_2 = a^2 \cos 2\tau \cos 2\phi$$

$$g_3 = a^2 \cos 2\tau \sin 2\phi$$

$$g = (g_0, g_1, g_2, g_3) = (g_0, g)$$

$$g_0 = \sqrt{g_1^2 + g_2^2 + g_3^2}$$

The three vector g is given by a point on the Poincare sphere, with polar angles 2ϕ and 2τ , and $g_0 = a^2$. The mapping concepts are the same as presented in chapter 1 from Balanis [9], but with a different form of parameters that have been presented above by Huynen [2]. See Figure and Figure 2.5.

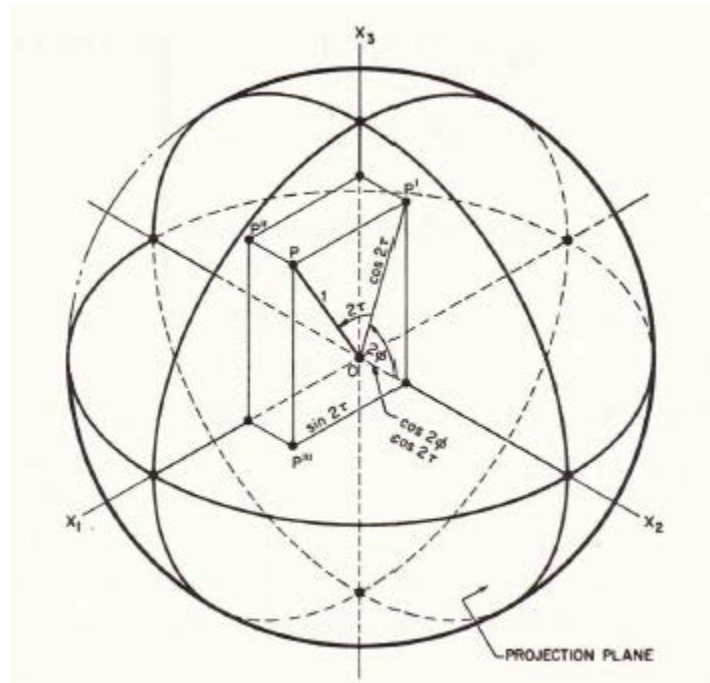

Figure 2.4 Poincare/Polarization Sphere from Huynen [2]

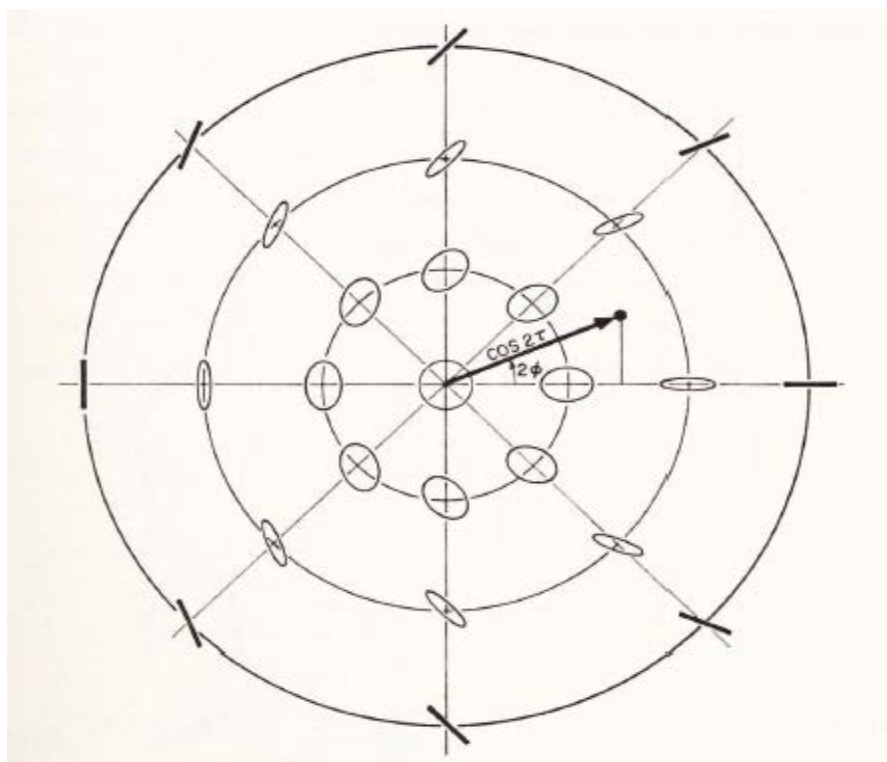

Figure 2.5 Polarization Chart from Huynen [2]

Much like the Poincare sphere represented from Balanis [9] in chapter 1, negative values of the ellipticity angle τ represent left-sensed polarization (one half hemisphere), and positive values represent right-sensed polarization. The circle separating the hemispheres, where $\tau = 0$ gives the points for linear polarizations. The poles, where $\tau = 45^\circ$ ($2\tau = 90^\circ$), are the points representing circular polarization.

It is well worth noting at this point that the elliptically polarized transmitting antenna \vec{a} can be treated as if it were facing the receiving antenna \vec{b} , and by operating on \vec{a} with a reflection matrix then \vec{a} can be transformed into the return signal from a target.

The scattering matrix can be considered a generalization of radar cross section observable. Radar cross section measurements measures the intensity of target scattering for a single polarization radar and transmission. However, the scattering matrix includes target scattering for all polarization combinations of the transmitter antenna, \vec{a} , and receiver antenna \vec{b} . The scattering matrix also contains the phase of the returned wave. The scattering matrix transforms the transmit polarization into the polarization of the scattered field \vec{E}^S , and is then sampled by the radar receiver. The vector identity $\vec{E}^S = T^S \vec{a}$ defines the target transformation T^S . The voltage is again measured at the receiver \vec{b}

$$V = \vec{E}^S \cdot \vec{b}_R^* (b, \phi_B, \tau_B) = T^S \vec{a} \cdot i^l \vec{b}(b, \phi_B, \tau_B) = iLT^S \vec{a} \cdot \vec{b} = T \vec{a} \cdot \vec{b} = \vec{a} \cdot T' \vec{b}$$

where

$$T = iLT^S = \begin{bmatrix} 1 & 0 \\ 0 & -1 \end{bmatrix} T^S = \begin{bmatrix} t_{11} & t_{12} \\ t_{21} & t_{22} \end{bmatrix}$$

$$L = \begin{bmatrix} -i & 0 \\ 0 & i \end{bmatrix}$$

which is of the form of the target scattering matrix T . Note that Huynen [2] annotates the scattering matrix as T , but as will be shown in chapter 3, Cameron [1] uses the variable S . From reciprocity

$$V = T\vec{a} \cdot \vec{b} = T\vec{b} \cdot \vec{a} = \vec{a} \cdot T\vec{b}$$

By comparing T and T' it can be seen that

$$T = T'$$

or

$$t_{12} = t_{21}$$

Thus T is reciprocal, hence it is a 2x2 symmetrical matrix. A radar target is determined by T and any symmetric T represents a physical target at a given aspect direction and frequency. However, it is not unique because many targets may have the same T at some exposure point. Also the same physical target can be represented by many T 's because T will change with direction and radar frequency. T is normally horizontally (H) and vertically (V) polarized unit vectors in Huynen [2]. The matrix is defined as

$$T = \begin{bmatrix} H H & H V \\ V H & V V \end{bmatrix} = \begin{bmatrix} t_{11} & t_{12} \\ t_{21} & t_{22} \end{bmatrix}$$

$H V$ is a complex number, t_{12} , that is proportional to the received horizontally polarized component, in amplitude and phase, of the returned signal while the target is the

illuminated vertically polarized transmitter. The scattering matrix is completely determined by the backscatter return signals from a target for horizontally and vertically polarized target illuminations. Once T is determined the backscattered return signal from the target is known for any combination of polarized antennas \vec{a} and \vec{b} . It should be noted that vectors \vec{a} , \vec{b} , and matrix T can be expressed in another polarization frame of reference. For example they could be expressed using a circular basis, with Right-Hand Circular and Left-Hand Circular polarization vectors as basic orthogonal unit vectors.

The properties of the scattering matrix, T , that are independent of special matrix representations are studied by solving an eigenvalue which is characteristic to the scattering matrix. Solutions to the eigenvalue problems of T are expressed by eigenvalues and eigenvectors. It is expected that the properties of the eigenvalues and eigenvectors may then be associated with physical properties of radar targets.

The characteristic eigenvalue problem of T is presented in the following form.

$$T\vec{x} = t\vec{x}^*$$

In general, there are two independent solutions to this equation.

$$T\vec{x}_1 = t_1\vec{x}_1^*$$

$$T\vec{x}_2 = t_2\vec{x}_2^*$$

From Huynen [2], the asterisks in the equations above denote a complex conjugate. This is not of the usual form, $A\vec{x}_1 = a\vec{x}_1$, because in the equations presented by Huynen [2]

\vec{x}_1 is phase determined with the phase of t_1 . The two eigenvectors are orthogonal if the eigenvalues are not equal in magnitude. Since T is a symmetric operator then

$$|T\vec{x}_1 \cdot \vec{x}_2| = |\vec{x}_1 \cdot T\vec{x}_2|$$

$$|t_1||\vec{x}_1^* \cdot \vec{x}_2| = |t_2||\vec{x}_1 \cdot \vec{x}_2^*|$$

If $|t_1| \neq |t_2|$ then

$$|\vec{x}_1 \cdot \vec{x}_2^*| = 0$$

$$\vec{x}_1 \cdot \vec{x}_2^* = 0$$

This is the condition of orthogonality of vectors \vec{x}_1 and \vec{x}_2 . Also, because the vectors are normalized

$$\vec{x}_1 \cdot \vec{x}_1^* = 1$$

$$\vec{x}_2 \cdot \vec{x}_2^* = 1$$

The vectors, \vec{x}_1 and \vec{x}_2 , are then considered to be an orthonormal set. A singularity transformation $U = (\vec{x}_1, \vec{x}_2)$ can be realized for which

$$U'U^* = \begin{bmatrix} \vec{x}_1 \cdot \vec{x}_1^* & \vec{x}_1 \cdot \vec{x}_2^* \\ \vec{x}_2 \cdot \vec{x}_1^* & \vec{x}_2 \cdot \vec{x}_2^* \end{bmatrix} = I$$

Where I is the unit matrix. Note that Huynen denotes the reciprocal of a matrix in the form A' . Using U to bring matrix T to diagonal form, then

$$TU = [T\vec{x}_1, T\vec{x}_2] = [t_1\vec{x}_1^*, t_2\vec{x}_2^*]$$

$$U'TU = \begin{bmatrix} \vec{x}_1 \cdot t_1 \vec{x}_1^* & \vec{x}_1 \cdot t_2 \vec{x}_2^* \\ \vec{x}_2 \cdot t_1 \vec{x}_1^* & \vec{x}_2 \cdot t_2 \vec{x}_2^* \end{bmatrix} = \begin{bmatrix} t_1 & 0 \\ 0 & t_2 \end{bmatrix}$$

This is defined as the diagonalized scattering matrix T_d .

$$T_d = \begin{bmatrix} t_1 & 0 \\ 0 & t_2 \end{bmatrix}$$

Using the unitary property, matrix T can be solved in terms of eigenvalues and eigenvectors.

$$T = U^* T_d U'$$

The properties of the backscatter power are determined next by using the total power per unit area contained in the backscatter return.

$$P_{tot} = E^S \cdot E^{S*} = T \vec{a} \cdot (T \vec{a})^*$$

The transmit polarization, \vec{a} , in the backscatter return power can be decomposed in terms of the eigenvectors, \vec{x}_1 and \vec{x}_2 , of T .

$$\vec{a} = a_1 \vec{x}_1 + a_2 \vec{x}_2$$

Using the orthonormal properties of \vec{x}_1 and \vec{x}_2 gives

$$P_{tot} = (a_1 T \vec{x}_1 + a_2 T \vec{x}_2) \cdot (a_1^* T^* \vec{x}_1^* + a_2^* T^* \vec{x}_2^*)$$

$$P_{tot} = (a_1 t_1 \vec{x}_1^* + a_2 t_2 \vec{x}_2^*) \cdot (a_1^* t_1 \vec{x}_1 + a_2^* t_2 \vec{x}_2)$$

$$P_{tot} = |a_1|^2 |t_1|^2 + |a_2|^2 |t_2|^2$$

Recall that the total transmit antenna gain is $g_0 = a^2 = |a_1|^2 + |a_2|^2$, hence

$$|a_1|^2 = a^2 - |a_2|^2.$$

$$P_{tot} = (a^2 - |a_2|^2)|t_1|^2 + |a_2|^2|t_2|^2$$

$$P_{tot} = a^2|t_1|^2 - |a_2|^2(|t_1|^2 - |t_2|^2)$$

Since the eigenvalues are not fixed, it can be assumed that $|t_1| \geq |t_2|$, without losing generality. The antenna is normalized to have a unit gain, $a = 1$. It is desirable to determine for which antenna polarization a , with fixed gain $a = 1$, the maximum power is returned from the target T . For total power $|a_2|$ is the only variable. It can be seen that P_{tot} is a maximum if $|a_2| = 0$. Hence $P_{tot} = |t_1|^2$ is the maximum. This is achieved by illuminating the target with a transmit antenna of unit gain and polarization $\vec{a} = \vec{x}_1$. The maximum power returned is given by parameters derived from the scattering matrix T , and is a target characteristic. The maximum return is defined as $P_{tot}(max) = |t_1|^2 = m^2$. The positive value m is the radar target magnitude, and it provides an overall electromagnetic measure of target size. This is analogous to wave magnitude, a , provides the measure of electromagnetic antenna size, or gain. The eigenvector has assumed physical significance called maximum polarization $\vec{x}_1 = \vec{m}$, and is defined by geometric variables ψ and τ_m .

$$\vec{m}(\psi, \tau_m) = \begin{bmatrix} \cos \psi & -\sin \psi \\ \sin \psi & \cos \psi \end{bmatrix} \begin{bmatrix} \cos \tau_m \\ i \sin \tau_m \end{bmatrix}$$

The two eigenvalues are written as

$$t_1 = me^{2i(v+\rho)}$$

$$t_2 = m \tan^2 \gamma e^{2i(v+\rho)}$$

It should be noted that the definition above agrees with $|t_1| \geq |t_2|$ if $\gamma \leq 45^\circ$, which is the range of γ .

The variable γ in the above equation is known as the characteristic angle, and is important because of its role as the sole variable in identifying canonical targets. The angle v is referred to as the “target skip angle”, and its values have a relationship to depolarization due to the number of bounces of the reflected signal. Its range is $-45^\circ \leq v \leq 45^\circ$. The variable ρ is called the absolute phase of the target. It’s also known as the “nuisance phase” because it may be altered arbitrarily by moving the radar target along the LOS direction, leaving the target’s attitude unaltered. It is a mixed target parameter and is determined by the target surface geometry, composition, and the target’s spatial position. The angle ψ is the target orientation angle, and can be made zero by rotating the radar target about the LOS axis while keeping the exposure unchanged. The angle τ_m is the ellipticity angle of the maximum polarization \vec{m} . It plays a significant role in determining target symmetry or asymmetry. When $\tau_m = 0$ the target is symmetric, and when $\tau_m \neq 0$ the target is asymmetric. It has a range is $-45^\circ \leq \tau_m \leq 45^\circ$.

It will now be shown that the six target parameters m, ρ, ψ, τ_m, v , and γ determine the target scattering matrix T . The singularity transformation U is found by substituting $\vec{x}_1 = \vec{m}$ and $\vec{x}_2 = \vec{m}_\perp$, where $\vec{m} = \vec{m}(\psi, \tau_m)$ and $\vec{m}_\perp = \vec{m}(\psi + \frac{\pi}{2}, -\tau_m)$.

These may be written as

$$\vec{m}(\psi, \tau_m) = e^{\psi J} e^{\tau_m K} \begin{bmatrix} 1 \\ 0 \end{bmatrix}$$

$$\vec{m}_\perp(\psi, \tau_m) = J e^{\psi J} e^{-\tau_m K} \begin{bmatrix} 1 \\ 0 \end{bmatrix} = e^{\psi J} e^{\tau_m K} \begin{bmatrix} 0 \\ 1 \end{bmatrix}$$

It can be shown that $\vec{m} \cdot \vec{m}_\perp^*$

$$\vec{m} \cdot \vec{m}_\perp^* = e^{\psi J} e^{\tau_m K} \begin{bmatrix} 1 \\ 0 \end{bmatrix} \cdot e^{\psi J} e^{-\tau_m K} \begin{bmatrix} 0 \\ 1 \end{bmatrix} = e^{-\tau_m K} (e^{-\psi J} e^{\psi J}) e^{\tau_m K} \begin{bmatrix} 1 \\ 0 \end{bmatrix} \cdot \begin{bmatrix} 0 \\ 1 \end{bmatrix} = 0$$

The unitary matrix is then

$$U = [\vec{m}, \vec{m}_\perp] = e^{\psi J} e^{\tau_m K} \begin{bmatrix} 1 & 0 \\ 0 & 1 \end{bmatrix} = e^{\psi J} e^{\tau_m K} = U(\psi, \tau_m)$$

Hence the scattering matrix T is then

$$T = U^* T_d U'^* = e^{\psi J} e^{-\tau_m K} e^{-\nu L} \begin{bmatrix} m & 0 \\ 0 & m \tan^2 \gamma \end{bmatrix} e^{-\nu L} e^{-\tau_m K} e^{-\psi J}$$

This can also be written as

$$U(\psi, \tau_m, \nu) = e^{\psi J} e^{\tau_m K} e^{\nu L}$$

$$U'(\psi, \tau_m, \nu) U^*(\psi, \tau_m, \nu) = (e^{\psi J} e^{-\tau_m K} e^{-\nu L}) (e^{\nu L} e^{\tau_m K} e^{-\psi J}) = I$$

$$T = U^*(\psi, \tau_m, \nu) m \begin{bmatrix} 1 & 0 \\ 0 & \tan^2 \gamma \end{bmatrix} U'^*(\psi, \tau_m, \nu)$$

This shows that T , diagonalized by a singularity transformation, has positive diagonal terms. The latter form of T is useful for obtaining geometrical canonical representations of T on the polarization sphere, where (ψ, τ_m, ν) are rotation angles of the sphere about three orthogonal axis, and γ is the sole identifier of canonical targets.

Further explanation is given here to describe each scattering component and their relationships to one another. First, the diagonalized component, T_d , is considered to be the most basic form of any known symmetric scatterer type, and the variable γ is axiomatic in nature and characterizes this canonical component. This component is what is realized if the scatterer is indeed symmetric along the horizontal axis in the LOS plane. As will be presented in chapter 3, the skip angle component can be included with the diagonalized component in the following form $\begin{pmatrix} me^{2iv} & 0 \\ 0 & m \tan^2 \gamma e^{-2iv} \end{pmatrix}$. This is useful for when dealing with problems that only concern orientation and symmetry angle components. Next the ellipticity angle component, $e^{-\tau_m K}$, is the component that describes the degree of symmetry of the target scatterer. Note, that as previously presented $e^{\tau_m K} = [\cos \tau_m I + \sin \tau_m K]$, and in matrix form it is written as $\begin{pmatrix} \cos \tau_m & -i \sin \tau_m \\ -i \sin \tau_m & \cos \tau_m \end{pmatrix}$. For the target scatterer, T , this component constitutes $e^{-\tau_m K} e^{-\tau_m K}$, which in matrix form yields the following equation.

$$\begin{aligned} & \begin{pmatrix} \cos \tau_m & -i \sin \tau_m \\ -i \sin \tau_m & \cos \tau_m \end{pmatrix} \begin{pmatrix} \cos \tau_m & -i \sin \tau_m \\ -i \sin \tau_m & \cos \tau_m \end{pmatrix} \\ & = \begin{pmatrix} \cos^2 \tau_m - \sin^2 \tau_m & -i \sin 2\tau_m \\ -i \sin 2\tau_m & \cos^2 \tau_m - \sin^2 \tau_m \end{pmatrix} \end{aligned}$$

If $\tau_m = \pm 45^\circ$ then this component operates on the diagonalized component and the result corresponds to an asymmetric scatterer. This means that for any horizontally polarized wave transmitted the received wave is vertically polarized or vice versa. If $\tau_m = 0$ then this component operates on the diagonalized component resulting in a symmetric scatterer. This means that for any horizontally or vertically polarized wave

transmitted, the received wave is horizontally or vertically polarized, respectively. The ellipticity angle by itself does not necessarily identify a given target as being asymmetric. If the ellipticity angle indicates that a target is asymmetric, it simply means that the target is asymmetric for a given orientation in the plane of LOS. If the target scatterer is indeed symmetric about some axis in the plane of LOS then there exist angle, ψ , from the horizontal at which the radar aperture must rotate to obtain symmetry from the scatter with respect to the horizontal axis. If the object is symmetric it is at this orientation angle in which $\tau_m = 0$. If the object is asymmetric in the plane of LOS no orientation angle exist at which $\tau_m = 0$.

Huynen [2] presents special radar target matrix representations. Figures 2.6 through 2.17 depict these representations. Figure 2.6 depicts a large sphere or flat plate at normal incidence of any material, and is represented by the unit matrix. The target parameters are $\gamma = 45^\circ$, $\nu = 0^\circ$, and $\tau_m = 0^\circ$. Figure 2.7 depicts a large trough (two planes intersecting at 90°) oriented with axis (the plane's line of intersection) horizontal or vertical. The target parameters are $\gamma = 45^\circ$, $\nu = +45^\circ$, $\tau_m = 0^\circ$, and $\psi = 0$ or 90° . In Figure 2.8 the target is symmetric, but not roll symmetric. The viewing angle for this trough is normal to the open face. The target has a two-bounce reflection characteristic associated with the maximum value of the "skip angle" $|\nu|$. The target is not orientation independent. The angle $\psi = 0$ or 90° changes only with the absolute phase of T . Figure 2.9 is a large trough as in 2-8, but with axis oriented at $+45^\circ$ or -45° . The target parameters are $\gamma = 45^\circ$, $\nu = +45^\circ$, $\tau_m = 0^\circ$, and $\psi = \pm 45^\circ$. This target completely depolarizes a horizontal or vertically polarized incoming illumination. Figure 2.10 depicts

a large trough with arbitrary orientation angle. The target parameters are $\gamma = 45^\circ$, $\nu = +45^\circ$, $\tau_m = 0^\circ$, and $\psi = \psi_a$. It should be noted that the trough targets in figures 2.8 through 2.10 all have identical reflections for incoming circular polarization. This is due to circular polarization being insensitive to target orientation. Figure 2.11 depicts a horizontal line target (wire). The target parameters are $\gamma = 0^\circ$, $\nu = \text{arbitrary}$, $\tau_m = 0^\circ$, and $\psi = 0^\circ$. Figure 2.12 depicts a line target with an arbitrary orientation angle. It's target parameters are $\gamma = 0^\circ$, $\nu = \text{arbitrary}$, $\tau_m = 0^\circ$, and $\psi = \psi_a$. Note that from Figure 2.12 below $T_L(\psi_a) = \frac{1}{2}T_O + \frac{1}{2}T_T$, showing that the line target may be considered to be composed of a sphere and a trough with proper phasing relative to each other. This concept holds true for all symmetric targets.

Figure 2.13 depicts a symmetric target with horizontal axis. It's parameters are γ , ν , $\tau_m = 0^\circ$, and $\psi = 0^\circ$. This target covers a wide class of physical targets such as cones, cylinders, ellipsoids, and combinations of these. All targets having an axis of roll-symmetry are symmetric at all aspect angles. Other targets considered to be non-symmetric, such as corner reflectors, may have planes of symmetry through a LOS direction and a target axis for which the target is symmetric. The ellipticity angle, τ_m , being zero is characteristic for all these targets. Since τ_m is the angle of maximum polarization \vec{m} , and because of symmetry of the target, there would be another maximum polarization \vec{m}' obtained from \vec{m} by reflection from the plane of symmetry. However, the eigenvalue theory for non-degenerate targets does not allow for two different polarizations. Hence, \vec{m} and \vec{m}' have to be of the same polarization. There are only two solutions. From figure 2.14 \vec{m} is "horizontal" (aligned with x-axis) or "vertical"

(aligned with y-axis). In both cases $\tau_m = 0^\circ$ (linear polarization) and $\psi = 0^\circ$ or 90° .

From Figure 2.15 the symmetric targets are characterized by $\tau_m = 0^\circ$ and $\psi = \psi_a$ or $\frac{\pi}{2} + \psi_a$. The polarization which gives the maximum return is linear and is either aligned with the axis of symmetry or orthogonal to it. For the general case of symmetric targets the maximum linear polarization may switch from “horizontal” to “vertical”, depending on aspect angle.

Figure 2.16 and 2.17 depict two non-symmetric targets, a helix with right screw sense and helix with left screw sense, respectively. The target parameters of Figure 2.16 are $\gamma = 0^\circ$, $\nu = \text{arbitrary}$, $\tau_m = 45^\circ$, and $\psi = 0^\circ$. The target parameters of Figure 2.17 are $\gamma = 0^\circ$, $\nu = \text{arbitrary}$, $\tau_m = -45^\circ$, and $\psi = 0^\circ$.

$$\mathbf{T}_O = \mathbf{I} = \begin{bmatrix} 1 & 0 \\ 0 & 1 \end{bmatrix} ; \text{ symbol } \begin{array}{c} | \\ \text{---} \bigcirc \text{---} \\ | \end{array}$$

Figure 2.6 A Large Sphere or Flat Plate at Normal Incidence of Any Material from Huynen [2]

$$\mathbf{T}_T = \pm \begin{bmatrix} 1 & 0 \\ 0 & -1 \end{bmatrix} = \pm i \mathbf{L} ; \text{ symbol } \begin{array}{c} | \\ \text{---} \text{---} \text{---} \\ | \end{array}$$

Figure 2.7 A Large Trough Oriented with Axis from Huynen [2]

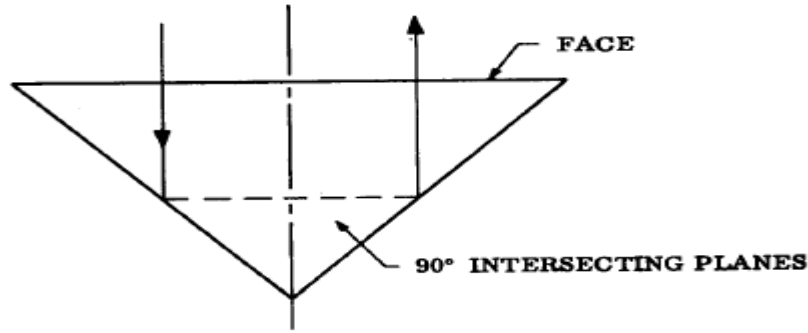

Figure 2.8 Reflection from a Trough from Huynen [2]

$$\mathbf{T}_T(45^\circ) = \pm \begin{bmatrix} 0 & 1 \\ 1 & 0 \end{bmatrix} = \mp i\mathbf{K} ; \text{ symbol}$$

Figure 2.9 A Large Trough with Axis Oriented at 45° or -45° from Huynen [2]

$$\mathbf{T}_T(\psi_a) = \begin{bmatrix} \cos 2\psi_a & \sin 2\psi_a \\ \sin 2\psi_a & -\cos 2\psi_a \end{bmatrix} ; \text{ symbol}$$

Figure 2.10 A Large Trough with Axis Oriented at an Arbitrary Angle ψ_a from Huynen [2]

$$\mathbf{T}_L = \begin{bmatrix} 1 & 0 \\ 0 & 0 \end{bmatrix} ; \text{ symbol}$$

Figure 2.11 Horizontal Line Target (Wire) from Huynen [2]

$$\mathbf{T}_L(\psi_a) = \begin{bmatrix} \cos^2 \psi_a & \sin \psi_a \cos \psi_a \\ \sin \psi_a \cos \psi_a & \sin^2 \psi_a \end{bmatrix} ; \text{ symbol}$$

Figure 2.12 Line Target A Large with Axis Oriented at an Arbitrary Angle ψ_a from Huynen [2]

$$T_S = \begin{bmatrix} e^{+2i\nu} & 0 \\ 0 & \tan^2 \gamma e^{-2i\nu} \end{bmatrix}; \text{ symbol } \begin{array}{c} y \\ \text{---} \\ \text{---} \\ \text{---} \\ \text{---} \\ \text{---} \\ \text{---} \\ \text{---} \\ \text{---} \\ \text{---} \\ x \end{array}$$

Figure 2.13 A Symmetric Target with Horizontal Axis from Huynen [2]

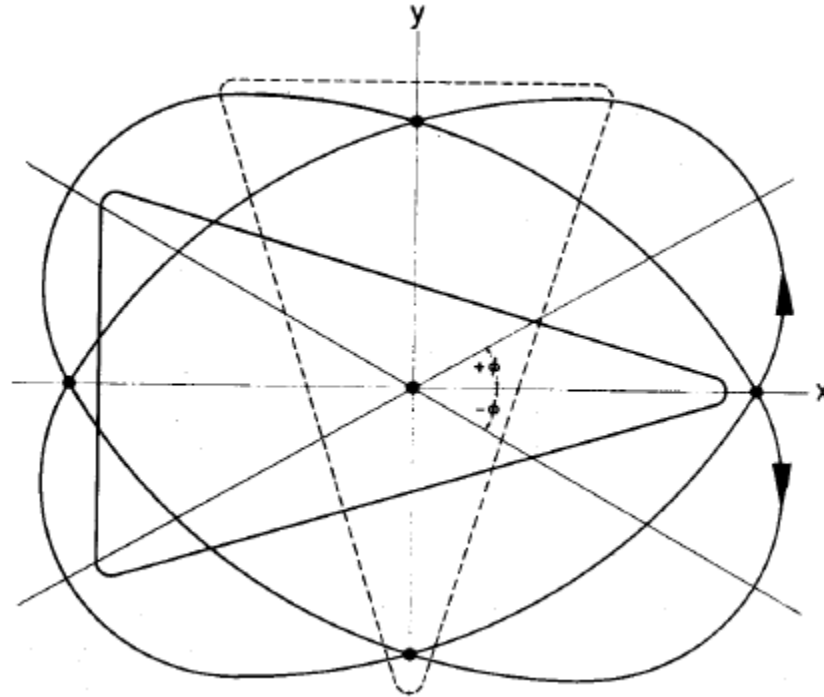

Figure 2.14 Symmetric Target from Huynen [2]

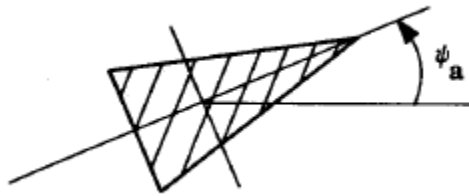

Figure 2.15 A Symmetric Target with Arbitrary Axis of Orientation from Huynen [2]

$$T_{HR} = \frac{1}{2} \begin{bmatrix} 1 & -i \\ -i & -1 \end{bmatrix} ; \text{ symbol } \img alt="Symbol for a right-screw helix, showing a spiral that winds clockwise as it moves away from the center." data-bbox="515 105 654 234"/>$$

Figure 2.16 A Helix with Right Screw Sense from Huynen [2]

$$T_{HL} = \frac{1}{2} \begin{bmatrix} 1 & i \\ i & -1 \end{bmatrix} ; \text{ symbol } \img alt="Symbol for a left-screw helix, showing a spiral that winds counter-clockwise as it moves away from the center." data-bbox="495 320 670 451"/>$$

Figure 2.17 A Helix with Left Screw Sense from Huynen [2]

In the next chapter it will be shown that the six target parameters defined above exist that satisfy Huynen's [2] decomposition above, but that they are not necessarily unique. Cameron's decomposition provides a method by which the polarization scattering matrix are decomposed into parts corresponding to non-reciprocal, asymmetric, and symmetric scatterers, with each being classified into one of eleven classes. Cameron's method involves direct computations of Huynen's parameters from measured data. These computations will provide unique values for τ_m and ψ (if it exists). The values calculated will provide criterion for the measured scatterer to pass in order to be categorized appropriately.

Chapter 3

Cameron Decomposition

From [1], William L. Cameron first proposed that the scattering matrix of an elemental scatter contains all the information necessary to predict the radar signal that will be returned by the scatterer when energized by a transmitted signal that has an arbitrary, but known, polarization state. An elemental scatterer refers to a scatterer that has a spatial extent, in any dimension, much smaller than the radar resolution in the same dimension. This means that the physical size of the object fits within the range and angular resolutions in that the object as a whole will be detected as a single object. Three objects have identical scattering matrices when their axis of symmetry is parallel to the radar line of sight, and thus indistinguishable to a radar when their spatial extent is much smaller than the radar's spatial resolution. These objects are a flat plate, sphere, and trihedral corner reflector. These objects are considered to be members of an equivalence class with respect to their common scattering matrix \tilde{S}_T . Cameron [1] represents the transmit and receive signals by the complex vectors $\vec{t}, \vec{r} \in C^2$. Where the transmit and receive vectors are \vec{t} and \vec{r} , respectively, and C^2 represents all of the possible two dimensional (i.e. horizontal and vertical) elements of the transmit and receive vectors. The receive vector can be obtained by operating on the transmit vector with the scattering matrix.

$$\tilde{S} = \begin{pmatrix} s_{11} & s_{12} \\ s_{21} & s_{22} \end{pmatrix}, s_{ij} \in \mathbb{C}, i, j \in \{1,2\}$$

The scattering matrix that represents the equivalence class containing the flat plate, sphere, and trihedral, \tilde{S}_T , is given by,

$$\tilde{S}_T = e^{i\rho} \begin{pmatrix} 1 & 0 \\ 0 & 1 \end{pmatrix}$$

The phase, ρ , is the nuisance phase because it depends on the range between the radar transmitter and the scatterer. The scattering matrices \tilde{S}_1 and \tilde{S}_2 ,

$$\tilde{S}_1 = c\tilde{S}_2$$

$$|c| = 1, c \in \mathbb{C},$$

are equivalent.

Sometimes it is convenient the matrix \tilde{S} as a vector \vec{S} where,

$$\vec{S} = \begin{pmatrix} s_1 \\ s_2 \\ s_3 \\ s_4 \end{pmatrix}$$

The vector and the matrix \vec{S} and \tilde{S} are related by the operators \mathbf{M} and \mathbf{V} where,

$$\mathbf{M}: \mathbb{C}^4 \rightarrow \mathbb{C}^2 \otimes \mathbb{C}^2$$

$$\mathbf{V}: \mathbb{C}^2 \otimes \mathbb{C}^2 \rightarrow \mathbb{C}^4$$

$\mathbb{C}^2 \otimes \mathbb{C}^2$ is the tensor product of the scattering matrix.

$$\vec{S} = \mathbf{V}\tilde{S} = \begin{pmatrix} S_{11} \\ S_{12} \\ S_{21} \\ S_{22} \end{pmatrix}$$

$$\tilde{S} = \mathbf{M}\vec{S} = \begin{pmatrix} S_1 & S_2 \\ S_3 & S_4 \end{pmatrix}$$

Under general conditions the reciprocity rule holds imposing symmetry on the scattering matrix.

$$(\tilde{S})_{12} = (\tilde{S})_{21}$$

The previous chapter presented Huynen's [2] method of decomposition utilizing parameters based on physical observables. Cameron [1] presents Huynen's [2] method in the following notation

$$\tilde{S} = \tilde{R}(\psi)\tilde{T}(\tau_m)\tilde{S}_d\tilde{T}(\tau_m)\tilde{R}(-\psi)$$

Where \tilde{S}_d is the diagonal matrix corresponding to symmetrical object with its axis of symmetry oriented horizontally in the plane orthogonal to the LOS.

$$\tilde{S}_d = \begin{bmatrix} m e^{2i(v+\rho)} & 0 \\ 0 & m \tan^2 \gamma e^{-2i(v-\rho)} \end{bmatrix}$$

The transformation matrices are given by

$$\tilde{R}(\psi) = \begin{pmatrix} \cos \psi & -\sin \psi \\ \sin \psi & \cos \psi \end{pmatrix}$$

$$\tilde{T}(\tau_m) = \begin{pmatrix} \cos \tau_m & -i \sin \tau_m \\ -i \sin \tau_m & \cos \tau_m \end{pmatrix}$$

Recall the parameters m , v , γ , ρ , τ_m , and ψ are the target magnitude, target skip angle, characteristic angle, absolute phase (nuisance phase), helicity angle, and target orientation angle. From the previous chapter, target symmetry and asymmetry is related to the helicity angle τ_m , in that $\tau_m = 0$ for symmetric targets and $\tau_m \neq 0$ for asymmetric targets. Also, $\tau_m = \pm \frac{\pi}{4}$ for helices. Therefore $\tilde{T}(\tau_m)$ introduces a degree of asymmetry in the scattering matrix dependent upon τ_m . The form of \tilde{S}_d is such that it corresponds to a horizontally oriented scatterer. Note that \tilde{S}_d is equivalent to T_d in Huynen. The rotation matrices $\tilde{R}(\psi)$ and $\tilde{R}(-\psi)$ transform \tilde{S}_d into a form corresponding to a scattering matrix rotated by an angle ψ from the horizontal in the plane orthogonal to the LOS. . Note that \tilde{S}_d is equivalent to T_d in Huynen, and $\tilde{R}(\psi)$ and $\tilde{T}(\tau_m)$ are equivalent to $e^{-\tau_m K}$ and $e^{\psi J}$, respectively. From Huynen [2] it can be shown that a set of parameters exist that will satisfy these transformations. However it can be shown that they are not unique. For example, the diagonal matrix corresponding to a dihedral scatterer obeys

$$\begin{aligned} \tilde{T}(\tau_m) \begin{pmatrix} 1 & 0 \\ 0 & -1 \end{pmatrix} \tilde{T}(\tau_m) &= \\ \begin{pmatrix} \cos \tau_m & -i \sin \tau_m \\ -i \sin \tau_m & \cos \tau_m \end{pmatrix} \begin{pmatrix} 1 & 0 \\ 0 & -1 \end{pmatrix} \begin{pmatrix} \cos \tau_m & -i \sin \tau_m \\ -i \sin \tau_m & \cos \tau_m \end{pmatrix} &= \\ \begin{pmatrix} \cos \tau_m & i \sin \tau_m \\ -i \sin \tau_m & -\cos \tau_m \end{pmatrix} \begin{pmatrix} \cos \tau_m & -i \sin \tau_m \\ -i \sin \tau_m & \cos \tau_m \end{pmatrix} &= \\ \begin{pmatrix} 1 & 0 \\ 0 & -1 \end{pmatrix} & \end{aligned}$$

It is clear the τ_m may be chosen arbitrarily ($\tau_m = 0$ and $\tau_m \neq 0$), and that finding a parameter set to satisfy the scattering matrix equations does not guarantee that the target observables can be inferred from those parameters.

Cameron [1] proposes a decomposition method where some feature of physical significance is extracted from the scattering matrix at each step of the decomposition. The proposed method assumes that the scattering matrices to be decomposed are derived from measurement and contain measurement errors. The parameters to be extracted are from Huynen's [2] set of parameters, but are derived by direct calculation so that their meaning need not to be inferred or interpreted from specific examples.

The most basic property derived from a scatterers scattering matrix is reciprocity. When viewed as vectors the scattering matrices that correspond to reciprocal targets occupy the subspace $W \subset C^4$, which is generated by the projection operator P_{rec} .

$$P_{rec} = \begin{pmatrix} 1 & 0 & 0 & 0 \\ 0 & \frac{1}{2} & \frac{1}{2} & 0 \\ 0 & \frac{1}{2} & \frac{1}{2} & 0 \\ 0 & 0 & 0 & 1 \end{pmatrix}$$

The scattering matrix can be uniquely decomposed into two orthogonal components within C^4 , \vec{S}_{rec} and \vec{S}_{\perp} . Here, $\vec{S}_{rec} \in W_{rec}$ and $\vec{S}_{\perp} \in W_{rec}^{\perp}$, where W_{rec}^{\perp} is the subspace of C^4 that is orthogonal to W_{rec} . The decomposition is given as

$$\vec{S} = \vec{S}_{rec} + \vec{S}_{\perp}$$

$$\vec{S}_{rec} = P_{rec}\vec{S}$$

$$\vec{S}_{\perp} = (I - P_{rec})\vec{S}$$

Where I is the identity operator on C^4 . The degree to which the scattering matrix obeys reciprocity is given by θ_{rec} , and is the angle between the scattering matrix and the reciprocal subspace W_{rec} .

$$\theta_{rec} = \cos^{-1} \|P_{rec}\hat{S}\|, 0 \leq \theta_{rec} \leq \frac{\pi}{2}$$

A scattering matrix which corresponds to a reciprocal scatterer, $\vec{S}_{rec} = \mathbf{M}\vec{S}_{rec}$ can be decomposed into symmetric and asymmetric scatterers. A symmetric scatterer is a scatterer that has an axis of symmetry in the plane orthogonal to the radar LOS. The reciprocal subspace cannot be further divided into orthogonal symmetric and asymmetric scatterer subspaces. This is because scattering matrices corresponding to symmetric scatterers do not form a subspace. For example, the scattering matrix for symmetric dihedral scatterers at different orientations and different phases is shown below.

$$\vec{S}_{D1} = \begin{pmatrix} 1 \\ 0 \\ 0 \\ -1 \end{pmatrix}$$

$$\vec{S}_{D2} = \begin{pmatrix} 0 \\ i \\ i \\ 0 \end{pmatrix}$$

If their sums were to be added then the result would correspond to an asymmetric scatterer (left helix).

$$\vec{S}_{D1} + \vec{S}_{D2} = \begin{pmatrix} 1 \\ i \\ i \\ -1 \end{pmatrix}$$

From Huynen [2], a scattering matrix corresponds to a symmetric scatterer if and only if it is diagonalizable by a rigid rotation transformation. Let the set of scattering matrices which correspond to symmetric scatterers be denoted by $X_{sym} \subset C^2 \otimes C^2$.

Then if $\tilde{S} \in X_{sym}$ there exist an angle ψ for which,

$$\tilde{R}(\psi)\tilde{S}\tilde{R}(-\psi) \in X_d$$

In the above X_d is the subspace of diagonal matrices in $C^2 \otimes C^2$ and $\tilde{R}(\psi)$ is the rotation matrix. Define the subspace $X_{rec} \subset C^2 \otimes C^2$ corresponding to $W_{rec} \subset C^4$ by the following

$$X_{rec} = \{\tilde{x} \in C^2 \otimes C^2: \tilde{x} = \mathbf{M}\vec{w}, \vec{w} \in W_{rec}\}$$

$$X_{sym} \subset X_{rec}$$

If $\tilde{S} \in X_{rec}$ then

$$\tilde{S} = \alpha\tilde{S}_a + \beta\tilde{S}_b + \gamma\tilde{S}_c$$

where \tilde{S}_a , \tilde{S}_b , and \tilde{S}_c are defined as the Pauli basis decomposition components.

$$\tilde{S}_a = \frac{1}{\sqrt{2}} \begin{pmatrix} 1 & 0 \\ 0 & 1 \end{pmatrix}$$

$$\tilde{S}_b = \frac{1}{\sqrt{2}} \begin{pmatrix} 1 & 0 \\ 0 & -1 \end{pmatrix}$$

$$\tilde{S}_c = \frac{1}{\sqrt{2}} \begin{pmatrix} 0 & 1 \\ 1 & 0 \end{pmatrix}$$

\tilde{S}_a is the component representing a flat plate, sphere, or trihedral. \tilde{S}_b is the component representing a dihedral. \tilde{S}_c is the component representing a diplane. The scattering matrix coefficients α , β , and γ represent the contribution each respective scattering component makes to the overall scatterer.

$$\alpha, \beta, \gamma \in \mathbb{C}$$

$$\alpha = \frac{S_{HH} + S_{VV}}{\sqrt{2}}$$

$$\beta = \frac{S_{HH} - S_{VV}}{\sqrt{2}}$$

$$\gamma = \sqrt{2}S_{HV}$$

A better characterization of the subset $X_{sym} \subset X_{rec}$ can be seen by examining the effects of rotation transformations on the basis set $\{\tilde{S}_a, \tilde{S}_b, \tilde{S}_c\}$.

$$\tilde{R}(\psi)\tilde{S}_a\tilde{R}(-\psi) = \tilde{S}_a$$

$$\tilde{R}(\psi)\tilde{S}_b\tilde{R}(-\psi) = \cos 2\psi \tilde{S}_b + \sin 2\psi \tilde{S}_c$$

$$\tilde{R}(\psi)\tilde{S}_c\tilde{R}(-\psi) = -\sin 2\psi \tilde{S}_b + \cos 2\psi \tilde{S}_c$$

If $\tilde{S} \in X_{sym}$ then using the above equations the following constraints can be obtained for β and γ

$$\beta \sin 2\psi + \gamma \cos 2\psi = 0$$

For $\tilde{S}_{sym} \in X_{sym}$, the equation above restricts the expansion of $\tilde{S} = \alpha\tilde{S}_a + \beta\tilde{S}_b + \gamma\tilde{S}_c$ to be of the form

$$\tilde{S}_{sym} = \alpha\tilde{S}_a + \partial(\cos \theta \tilde{S}_b + \sin \theta \tilde{S}_c)$$

where $\alpha, \partial \in \mathbb{C}$ and $\theta \in [0, 2\pi]$. Define the basis vectors $\tilde{S}_a, \tilde{S}_b, \tilde{S}_c$ by

$$\hat{S}_q = \mathbf{V}\tilde{S}_q, \quad q \in \{a, b, c\}$$

and the set of scattering matrices in vector form representing symmetric scatterers by

$$W_{sym} = \{\vec{v} \in W_{rec} : \vec{v} = \mathbf{V}\tilde{x}, \tilde{x} \in X_{sym}\}$$

An alternative definition of W_{sym} is

$$W_{sym} = \{\vec{v} \in \mathbb{C}^4 : \vec{v} = \alpha\tilde{S}_a + \partial(\cos \theta \tilde{S}_b + \sin \theta \tilde{S}_c), \alpha, \partial \in \mathbb{C}, \theta \in [0, 2\pi]\}$$

A decomposition is sought for $\vec{S}_{rec} \in W_{rec}$ such that

$$\vec{S}_{rec} = \vec{S}_{sym} + \vec{S}_2$$

$$\vec{S}_{sym} = (\vec{S}_{rec}, \hat{S}_a)\hat{S}_a + (\vec{S}_{rec}, \hat{S}')\hat{S}'$$

where $\hat{S}' = \cos \theta \tilde{S}_b + \sin \theta \tilde{S}_c$. Here θ is chosen such that $|\vec{S}_{rec}, \hat{S}'|$ is a maximum.

These conditions guarantee that \vec{S}_{sym} is the largest symmetric component which can be

extracted from \vec{S}_{rec} . \vec{S}_{sym} is obtained by operating on \vec{S}_{rec} with the \mathbf{D} operator derived in Cameron [1],

$$\vec{S}_{sym} = \mathbf{D}\vec{S}_{rec}$$

where

$$\mathbf{D}\vec{S} = (\vec{S}, \hat{S}_a)\hat{S}_a + (\vec{S}, \hat{S}')\hat{S}'$$

To further explain, it is desired that θ be chosen to maximize the symmetrical component of \vec{S}_{rec} . From Cameron [1], this is achieved if and only if the function $f(\theta)$ is maximized. Where

$$f(\theta) = \frac{1}{2}((|\beta|^2 + |\gamma|^2) + (|\beta|^2 - |\gamma|^2) \cos(2\theta) + (\beta\gamma^* + \beta^*\gamma) \sin(2\theta))$$

The relative sign be the $\cos(2\theta)$ and $\sin(2\theta)$ is important for maximizing this function so the range of θ can be restricted to $\theta \in \left[-\frac{\pi}{2}, \frac{\pi}{2}\right]$. The function, $f(\theta)$, is at the maximum when its first derivative is zero and second derivative is negative or at one the endpoints on the interval $\left[-\frac{\pi}{2}, \frac{\pi}{2}\right]$. For the first derivative to be zero

$$f'(\theta) = (-(|\beta|^2 - |\gamma|^2) \sin(2\theta) + (\beta\gamma^* + \beta^*\gamma) \cos(2\theta))$$

$$f'(\theta) = 0 \begin{cases} \tan 2\theta = \frac{\beta\gamma^* + \beta^*\gamma}{|\beta|^2 - |\gamma|^2}, |\beta|^2 \neq |\gamma|^2 \\ \cos(2\theta) = 0, \text{ or } \beta\gamma^* + \beta^*\gamma = 0, \text{ otherwise} \end{cases}$$

For the second derivative to be negative

$$f''(\theta) = -2(|\beta|^2 - |\gamma|^2) \cos(2\theta) - 2(\beta\gamma^* + \beta^*\gamma) \sin(2\theta)$$

$$(\beta\gamma^* + \beta^*\gamma) \sin(2\theta) > -(|\beta|^2 - |\gamma|^2) \cos(2\theta)$$

If $|\beta|^2 = |\gamma|^2$ then the conditions on the first and second derivatives require

$$\theta = \begin{cases} \frac{\pi}{4}, \beta\gamma^* + \beta^*\gamma \geq 0 \\ -\frac{\pi}{4}, \beta\gamma^* + \beta^*\gamma < 0 \end{cases}$$

The case in which $|\beta|^2 = |\gamma|^2$ and $\beta\gamma^* + \beta^*\gamma = 0$ occurs if and only if the scattering matrix is part of the equivalence class of scattering matrices corresponding to helices,

$$\vec{S} = c \begin{pmatrix} 1 \\ \pm i \\ \pm i \\ -1 \end{pmatrix}. \text{ In this case } f(\theta) \text{ is constant and } \theta = \frac{\pi}{4} \text{ is arbitrarily chosen.}$$

In the case that $|\beta|^2 \neq |\gamma|^2$ the condition on the first derivative requires

$$\tan 2\theta = \frac{\beta\gamma^* + \beta^*\gamma}{|\beta|^2 - |\gamma|^2}$$

and let

$$\sin \chi = \frac{\beta\gamma^* + \beta^*\gamma}{\sqrt{(\beta\gamma^* + \beta^*\gamma)^2 + (|\beta|^2 - |\gamma|^2)^2}}$$

$$\cos \chi = \frac{|\beta|^2 - |\gamma|^2}{\sqrt{(\beta\gamma^* + \beta^*\gamma)^2 + (|\beta|^2 - |\gamma|^2)^2}}$$

The conditions on the first and second derivatives can be written as

$$\tan 2\theta = \tan \chi$$

and

$$\sin \chi \sin(2\theta) > -\cos \chi \cos(2\theta)$$

These conditions are satisfied for

$$\theta = \frac{1}{2}\chi$$

This shows that $\frac{1}{2} \tan^{-1} \frac{\beta\gamma^* + \beta^*\gamma}{|\beta|^2 - |\gamma|^2}$ yields the angle θ that provides a maximum for

$\hat{S}' = \cos \theta \tilde{S}_b + \sin \theta \tilde{S}_c$, and in turn yields a maximum for the symmetrical component of \vec{S}_{rec} , $(\vec{S}, \hat{S}_a)\hat{S}_a + (\vec{S}, \hat{S}')\hat{S}'$. This is of great importance because the symmetric component of a reciprocal scatterer can be a combination of any of components $\alpha\tilde{S}_a$, $\beta\tilde{S}_b$, and $\gamma\tilde{S}_c$. It can be seen by operating on the trihedral component that determining its symmetry is not dependent on orientation. However, to find the line symmetry of a combination of dihedral and diplane components requires the process above to find the axis of maximum symmetry.

The degree to which \vec{S}_{rec} deviates from belonging to W_{sym} is measured by the angle τ ,

$$\tau = \cos^{-1} \left| \frac{(\vec{S}_{rec}, \mathbf{D}\vec{S}_{rec})}{\|\vec{S}_{rec}\| \cdot \|\mathbf{D}\vec{S}_{rec}\|} \right|, 0 \leq \tau \leq \frac{\pi}{4}$$

If $\tau = 0$ then $\vec{S}_{rec} \in W_{sym}$. The maximum asymmetry condition, $\tau = \frac{\pi}{4}$, occurs if \vec{S}_{rec} is the scattering matrix of a left or right helix.

The symmetric component of a scattering matrix is diagonalized by pre and post multiplying by the appropriate rotation matrix and its inverse. The angle ψ is calculated as

$$\psi' = -\frac{1}{2} \tan^{-1} \left(\frac{(\mathbf{D}\vec{S}_{rec}, \tilde{S}_c)}{(\mathbf{D}\vec{S}_{rec}, \tilde{S}_b)} \right) = -\frac{1}{4} \chi, \quad -\pi < \chi \leq \pi$$

Note that $\psi' \pm \frac{\pi}{2}$ also works as the diagonalization angle. However, using $\psi' \pm \frac{\pi}{2}$ reverses the diagonal elements. Choose the diagonalization angle ψ such that the upper diagonal element is a maximum and $\psi \in \left(-\frac{\pi}{2}, \frac{\pi}{2}\right)$. For example

$$\psi \in \left\{ \psi', \psi' \pm \frac{\pi}{2} \right\} \cap \left(-\frac{\pi}{2}, \frac{\pi}{2}\right)$$

$$\tilde{S}_d = \tilde{R}(\psi) [\mathbf{M}\mathbf{D}\vec{S}_{rec}] \tilde{R}(\psi), \quad \tilde{S}_d \in X_d$$

and

$$\left| (\tilde{S}_d)_{11} \right| \geq \left| (\tilde{S}_d)_{22} \right|$$

This removes the orientation bias discussed by Huynen [2].

The rotation angle is ambiguous because it is dependent on the arc tangent function. Any $\psi' + n\pi$, where $n \in J$ and J being a set of integers, will satisfy the arc tangent function above. For this reason the range of the rotation angle is restricted to $\left(-\frac{\pi}{2}, \frac{\pi}{2}\right)$, which is the smallest range, generally speaking, for which there is no ambiguity in the rotation angle. Some scatterer types may have symmetries resulting in ambiguities in ψ on $\left(-\frac{\pi}{2}, \frac{\pi}{2}\right)$. If this is the case then further restriction of the range of variation of ψ is needed.

Let \tilde{S}_d be a diagonal matrix of a symmetric scatterer. Also, let \tilde{S}_d normalized,

$$\|\mathbf{V}\tilde{S}_d\| = 1$$

If an ambiguity exists in the rotation angle ψ of the scatterer corresponding to \tilde{S}_d then there exists an angle $\Delta\psi$ such that a rotation of \tilde{S}_d by $\Delta\psi$ yields a scattering matrix belonging to the same equivalence class as \tilde{S}_d .

$$|(\mathbf{V}[\tilde{R}(\Delta\psi)\tilde{S}_d\tilde{R}(-\Delta\psi)], \mathbf{V}\tilde{S}_d)| = 1$$

Writing \tilde{S}_d as

$$\tilde{S}_d = \begin{pmatrix} a & 0 \\ 0 & b \end{pmatrix}$$

and substituting into the previous equation and simplifying yields

$$|1 + \eta \sin^2(\Delta\psi)| = 1$$

where

$$\eta = ab^* + a^*b - 1$$

It should be noted that $\eta \in R$ and the range of variation is $-2 \leq \eta \leq 0$. If $-2 \leq \eta \leq 0$ then $|1 + \eta \sin^2(\Delta\psi)| = 1$ requires that $\Delta\psi = n\pi$ and the unambiguous range of ψ is $\psi \in \left(-\frac{\pi}{2}, \frac{\pi}{2}\right)$. If $\eta = 0$ then $|1 + \eta \sin^2(\Delta\psi)| = 1$ is satisfied for any value of $\Delta\psi$. This case occurs only if $\tilde{S}_d = e^{i\rho}\tilde{S}_a$. For example, \tilde{S}_d corresponds to a trihedral scatterer. For this case choose $\psi = 0$ since the response of a trihedral is rotation invariant. If $\eta = -2$ then $|1 + \eta \sin^2(\Delta\psi)| = 1$ for $\Delta\psi = (2n - 1)\frac{\pi}{2}, n \in J$. This case occurs if $\tilde{S}_d = e^{i\rho}\tilde{S}_b$.

For example, \tilde{S}_d corresponds to a dihedral scatterer. For this case restrict ψ to $(-\frac{\pi}{4}, \frac{\pi}{4})$

using ψ_0 replacing ψ in the diagonalization equations above and

$$\psi = \begin{cases} \psi_0 - \frac{\pi}{2}, & \frac{\pi}{4} < \psi_0 \\ \psi_0, & -\frac{\pi}{4} < \psi_0 \leq \frac{\pi}{4} \\ \psi_0 + \frac{\pi}{2}, & \psi_0 \leq -\frac{\pi}{4} \end{cases}$$

From Cameron [1], specific scatterer types are described. An arbitrary scattering matrix $\vec{S} \in C^4$ is compared to a test scattering matrix $\hat{S}_t \in C^4$ by computing the angle θ_t

$$\theta_t = \cos^{-1} \left| \frac{(\vec{S}, \hat{S}_t)}{\|\vec{S}\|} \right|, 0 \leq \theta_t \leq \frac{\pi}{2}$$

The two scattering matrices are of the same equivalence class if $\theta_t = 0$; they are orthogonal if $\theta_t = \frac{\pi}{2}$. Representatives of the equivalence classes of the asymmetric

scattering matrices for left and right helices are

$$\tilde{S}_{hl} = \frac{1}{2} \begin{pmatrix} 1 & i \\ i & 1 \end{pmatrix}$$

$$\tilde{S}_{hr} = \frac{1}{2} \begin{pmatrix} 1 & -i \\ -i & 1 \end{pmatrix}$$

Common symmetric scatterers and their scattering matrices are

$$tri\text{hedral} = \frac{1}{\sqrt{2}} \begin{pmatrix} 1 & 0 \\ 0 & 1 \end{pmatrix}$$

$$di\text{plane} = \frac{1}{\sqrt{2}} \begin{pmatrix} 1 & 0 \\ 0 & -1 \end{pmatrix}$$

$$dipole = \begin{pmatrix} 1 & 0 \\ 0 & 0 \end{pmatrix}$$

$$cylinder = \frac{1}{\sqrt{5}} \begin{pmatrix} 2 & 0 \\ 0 & 1 \end{pmatrix}$$

$$narrow\ diplane = \frac{1}{\sqrt{5}} \begin{pmatrix} 2 & 0 \\ 0 & -1 \end{pmatrix}$$

$$quarter\ wave\ device = \frac{1}{\sqrt{2}} \begin{pmatrix} 1 & 0 \\ 0 & i \end{pmatrix}$$

As presented above Cameron [1] has provided a method of decomposition in which the properties of reciprocity, symmetry, and orientation angle are directly calculated from the scattering matrix and matched to a specific scatterer type. Cameron [1] has also provided a classification scheme based on the previously calculated features, see Figure 3.1.

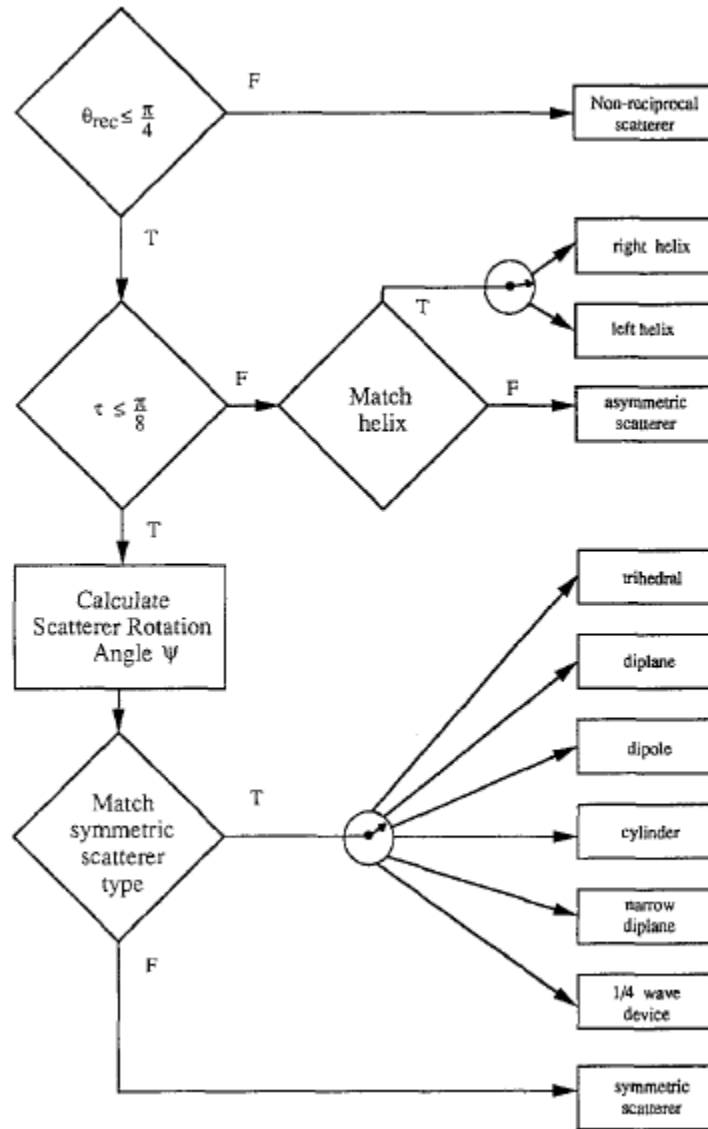

Figure 3.1 Scattering Matrix Classification Scheme from Cameron [1]

As shown in Figure 3.1, the scattering matrix (in vector form) \vec{S} is tested to determine the degree to which it obeys reciprocity. If $\theta_{rec} > \frac{\pi}{4}$ then the non-reciprocal component of the scattering matrix is dominate. Thus the scattering matrix corresponds to a non-reciprocal scatterer. If $\theta_{rec} \leq \frac{\pi}{4}$ then the degree of symmetry, τ , is calculated. If $\tau > \frac{\pi}{8}$ the scattering corresponds to an asymmetric scatterer, and the degree to which

the scattering matrix matches a left or right helix is calculated. If the angle is below a threshold the scattering matrix is determined to correspond to a left or right helix, otherwise it is determined to be an asymmetric scatterer. If $\tau \leq \frac{\pi}{8}$ then the scattering matrix corresponds to a symmetric scatterer. The scattering matrix is then compared to a list of symmetric scatterers (presented above). If a match is found the scattering matrix is determined to be that of the matched scatterer type, otherwise the scattering matrix is determined to be that of a symmetric scatterer. For symmetric scatterers that have an orientation, the orientation angle ψ is calculated.

Figures 3.2 and 3.3 depict ISAR results applying Cameron's [1] decomposition and classification scheme. In Figure 3.2 trihedrals and dihedrals are indicated with triangles and squares, respectively. It should be noted that the middle image of Figure 3.3 also utilizes Cameron's [1] point scatterer extraction technique not presented here.

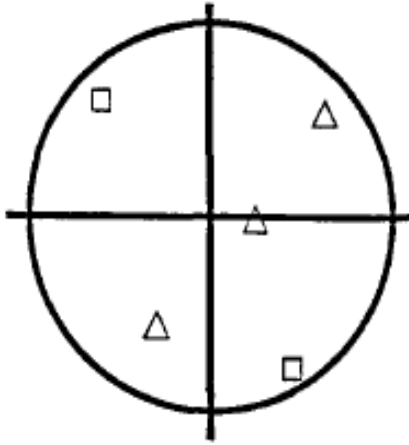

Figure 3.2 Diagram of Scatterer Types and Positions for Simple Array from Cameron [1]

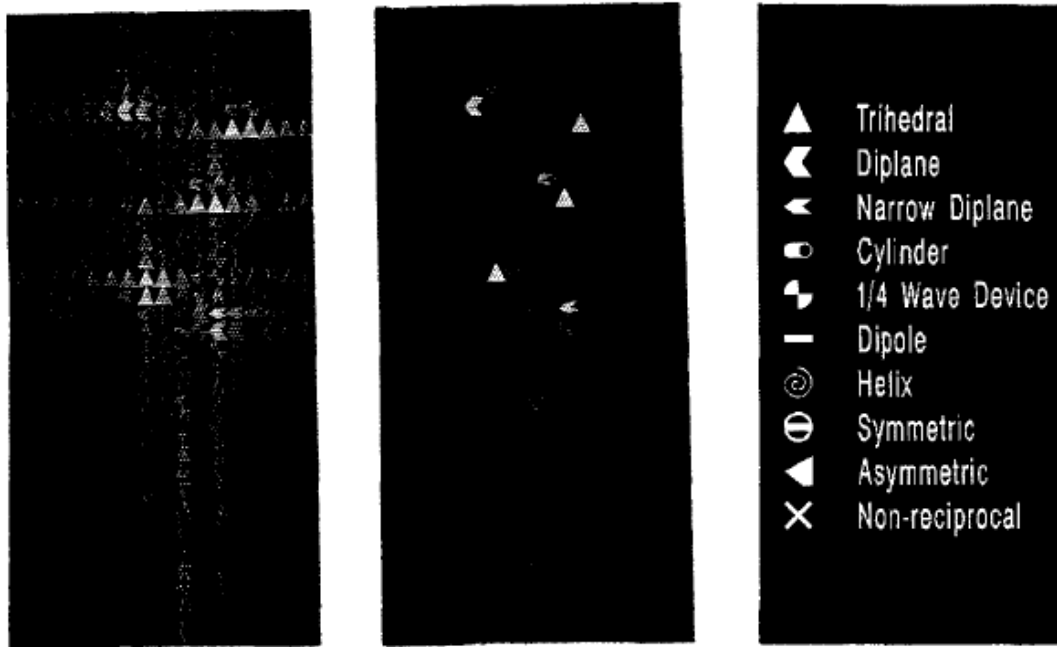

Figure 3.3 Full Polarimetric RCS Images of Scatterers from Cameron [1]

Appendix A includes a MATLAB script, written by the author, that processes a manually entered scattering matrix and categorizes it via Cameron decomposition as reciprocal, non-reciprocal, asymmetric, symmetric, right helix, left helix, trihedral, diplane, dipole, cylinder, narrow diplane, and quarter-wave device. The program also notifies the user if an asymmetric or symmetric scatterer is of unknown type. Based on the set of inputs from the user the script defines sets of parameters to be put under test. These parameters include the scattering matrix, scattering vector, scattering matrix and vector normalized components, angle of reciprocity, trihedral scattering vector, diplane scattering vector, dipole scattering vector, alpha, beta, and gamma.

First the angle of reciprocity is calculated by operating on the scattering vector with the projection operator, P , by taking the arccosine of the dot product. This determines the degree to which the scattering vector obeys reciprocity. If the reciprocity angle is greater than $\frac{\pi}{4}$ then the program notifies the user that the scatterer under test is non-reciprocal, and the processing is complete. If the reciprocity angle is less than $\frac{\pi}{4}$ then the scatterer continues to be processed. The program then tests the Pauli basis decomposition components, determined from user input, to compare beta and gamma. The conditions of the first and second derivatives of $f(\theta)$ is then tested in order to determine the value of theta. The following tests are done on beta and gamma to determine the maximum angle of symmetry (theta): $|\beta|^2 = |\gamma|^2$ and $|\beta|^2 \neq 0$ and $|\gamma|^2 \neq 0$, $|\beta|^2 = |\gamma|^2$ and $|\beta|^2 = 0$ and $|\gamma|^2 = 0$, and $|\beta|^2 \neq |\gamma|^2$. For the case $|\beta|^2 = |\gamma|^2$ and $|\beta|^2 \neq 0$ and $|\gamma|^2 \neq 0$, theta is determined for $\beta\gamma^* + \beta^*\gamma \geq 0$ or

$\beta\gamma^* + \beta^*\gamma < 0$. Once theta is determined the D operator is calculated and then tau. If tau is less than $\frac{\pi}{8}$ then the orientation angle, psi, is calculated. Psi is then used to operate on the symmetrical component of the scattering matrix with the rotational transformation matrix. This provides additional constraints for symmetry. Once it has been determined that the scattering matrix is symmetric then the scatterer under test is compared to known symmetric scatterer types. The classification is then output to the user. The same process applies for the other tests. For the case in which $|\beta|^2 = |\gamma|^2$ and $\beta\gamma^* + \beta^*\gamma = 0$ the scattering matrix is identified to be asymmetric and is tested to determine to what degree it matches a left or right helix, there is no need to determine theta because it is arbitrary. If the matrix matches to within five degrees of the helix under test then the user is notified that the matrix under test is a left or right helix. The case in which $|\beta|^2 = |\gamma|^2$ && $|\beta|^2 = 0$ && $|\gamma|^2 = 0$ is unique in that this should only apply if the scatterer under test is a flat plate, sphere, or trihedral that all share the same scattering matrix. The case in which $|\beta|^2 \neq |\gamma|^2$ follows the same process as described above in determining symmetry. In this case the arctan function, $\frac{1}{2} \tan^{-1} \frac{\beta\gamma^* + \beta^*\gamma}{|\beta|^2 - |\gamma|^2}$, is utilized to determine theta.

Chapter 4

Cameron Decomposition and Polarimetric SAR Applications

Synthetic aperture radar (SAR) sensors have been used for many applications including land cover characterization and classification, detection and characterization of man-made objects, crashed aircraft, maritime vessels, military vehicles, land mines, unexploded ordnance, etc. George Rogers [7], Houra Rais [7], and William Cameron [7] have presented a method in decomposing full polarimetric SAR data utilizing Cameron decomposition and weighted log likelihood from sub-aperture data sets to determine canonical scatterer types. Their method of applying Cameron Decomposition to SAR data sets is presented here.

From Rogers, et al, [7] Coherent decompositions are based on single pixel responses, and are applied directly to the measured complex scattering matrix associated with each pixel. These decompositions produce valid results for those resolution cells that contain single dominant scattering centers. In this context the “scattering center” refers to the measurement of the scattering matrix where the interaction of the electromagnetic wave with the object is described by four complex numbers, and interpreting as taking place at a scattering center (phase center). If

dominant scatterer is not present in the resolution cell then the result is a speckle type response, which results in an effective random scattering matrix, and thus a random response. This susceptibility to speckle type response exposes a flaw in coherent decompositions.

As presented in the previous chapter, Cameron decomposition decomposes an arbitrary scattering matrix into two orthogonal nonreciprocal and reciprocal scattering components. The reciprocal components are further decomposed into maximum and minimum symmetric scattering components. The decomposition contains several meaningful and non-ambiguous decomposition parameters. Cameron [1] also presents a set of canonical scatterer types including the trihedral, dipole, dihedral, and quarter-wave device. These canonical scattering types provide a basis for a classification scheme. Rogers [7], Rais [7], and Cameron [7] present an approach to using multiple observations of the scattering matrix to distinguish between different sizes and shapes of objects that may only occupy a single pixel.

A SAR image based on a single aperture can be replaced by a sequence of sub-aperture images that correspond to different subsets of the original aperture and hence sample the scattering matrix at slightly different aspects. Then by comparing the expected response for a given target to the multiple samples of the observed response the likelihood that the response is a particular signature, corresponding to both a size and a shape, can be determined. Furthermore, additional information is obtained to differentiate the response from a speckle. Cameron decomposition is used to

nonlinearly transform the four polarimetric channels (scattering matrix) to the Cameron basis or feature space. The feature space is then used to compare the observed values at a pixel to the reference signature values using a weighted log-likelihood approach. It should be noted that four observations should be the absolute minimum to be able to perform the signature based detections. In the limit of a single observation the observations of a sphere, trihedral, and a flat plate are identical. Multiple observations are required to differentiate between them. Increasing the number of observations as well as the overall angular extent of the synthetic aperture will improve the ability to differentiate between the response due to different objects as well as their orientations. Also, the reference object must be present in the resolution cell and must be the dominant source of the return from the resolution cell.

Limits on the classification scheme are presented by Rogers. Cameron's decomposition and classification scheme makes for a useful display of the scattering characteristics of a known extended target, but is not particularly useful for picking out a single pixel from background clutter. This is because a fraction of the pixels in a single look complex image with speckle type responses will pass any reciprocity test, and have sufficient symmetry that those pixels will get classified as one of the elementary symmetric scattering center types. This can result in an unacceptable amount of false positives for relatively smaller targets. Another problem identified is that the classification scheme of the scattering mechanism does not account for noise, mild clutter, or variations in the observed response. Also there are many objects in the real world that do not correspond to the elementary scattering shapes of Cameron

decomposition that may be desired to detect and discriminate from other similar objects. It may be possible to carve Cameron's state space even further to include more scatterer types, but this is not considered to be a viable solution assuming the responses of additional shapes are even known. Thus Rogers, et al, present the formulation of a weighted log likelihood approach to overcome these limitations.

As previously noted, a single sample of the scattering matrix is insufficient to discriminate between a response due to a single dominant scattering mechanism a speckle type response. Rogers, et al, present an approach to sample the scattering matrix through a range of aspects, which is done through the use of sub-aperture images. From the ordered set of sub-aperture images an ordered set of feature vectors based on the Cameron decomposition for each pixel in the original image is obtained. Each component feature of each of the set of feature vectors then becomes an observation on the scattering mechanism for that pixel. For each observation they use the observed value and the ideal signature value to compute a likelihood that the observation corresponds to that signature. Since the different signatures provide differing values in discriminating between different signatures, they weight each likelihood. Since the maximum possible likelihood is one and the product of a large number of small likelihoods can be vanishingly small, they follow the usual practice of computing the log-likelihood instead. The total log likelihood is then the sum of the individual log-likelihoods multiplied by their respective weights.

From [7], Let x'_{ij} be the observed value for feature j from sub-aperture i and $x_{kij}(\omega)$ be the ideal value for feature j , sub-aperture i , and signature k based on an assumed azimuthal orientation ω . The nonlinear ramp function based on the difference between the observed and ideal values as

$$d(x_{kij}(\omega) - x'_{ij}) = 0 \text{ if } |x_{kij}(\omega) - x'_{ij}| < a_j$$

$$d(x_{kij}(\omega) - x'_{ij}) = |x_{kij}(\omega) - x'_{ij}| - a_j \text{ if } a_j \leq \left| \frac{x_{kij}(\omega) - x'_{ij}}{b_j - a_j} \right| \leq b_j$$

$$d(x_{kij}(\omega) - x'_{ij}) = 1 \text{ if } |x_{kij}(\omega) - x'_{ij}| > b_j$$

where a_j is the value below which it is undesirable to penalize the likelihood and b_j is the value above which we are willing to declare the likelihood zero. The estimated likelihood that an observation corresponds to a specific signature k at orientation ω is taken as

$$\hat{L}_{kij}(\omega) = (1 - d(x_{kij}(\omega) - x'_{ij}))$$

The final weighted log-likelihood based on an assumed orientation ω is then

$$\log \hat{L}_k(\omega) = \sum_i \sum_j w_j \log (\hat{L}_{kij}(\omega))$$

where the index j is summed over the observations corresponding to a single sub-aperture, the index i is summed over the sub-apertures used, and the index k corresponds to a specific signature k . The value ω that maximizes the log likelihood becomes the likelihood based estimate of the orientation signature k .

$$\hat{\omega}_k: \log \hat{L}_k(\hat{\omega}_k) = \sup_{\omega} [\log \hat{L}_k(\omega)]$$

Symmetry weight is defined as

$$w_{sym} = \frac{\sqrt{|S_{HH}|^2 + |S_{VV}|^2}}{\sqrt{|S_{HH}|^2 + |S_{HV}|^2 + |S_{VH}|^2 + |S_{VV}|^2}}$$

From Rogers, et al, [7] the weighted log likelihood enables the computation of a Cross-Likelihood Matrix. Although not presented here, the Cross-Likelihood Matrix provides a means to assess how similar signatures are for a specific set of collection parameters.

In summary, the application of coherent decomposition, in particular Cameron decomposition, polarimetric SAR has been described above. This application uses changes in the scattering matrix across a synthetic aperture to identify the pixel by pixel likelihood that the observed response is due to a known reference object. Figure 4.1 shows signature detections for dihedrals, trihedrals, and cylinders. The detected dihedral sizes vary from 0.9λ to 4λ , the detected trihedrals were based on 2.44λ , and the detected cylinders were based on 2λ [7]. Figure 4.2 shows signature detections for Tail Dihedrals, including a site containing a real aircraft tail section[7].

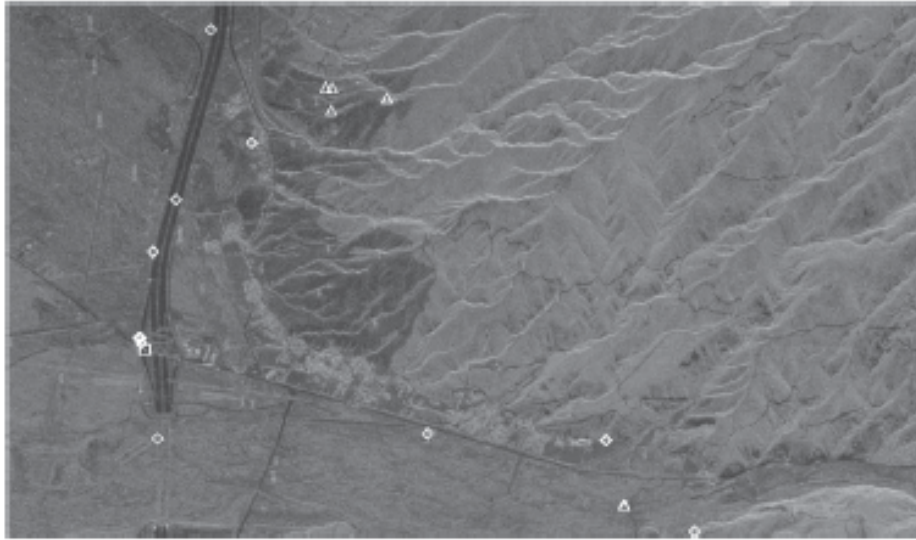

Figure 4.1 Signature Detections Shown for Dihedrals, Trihedrals, and Cylinders from Rogers [7]

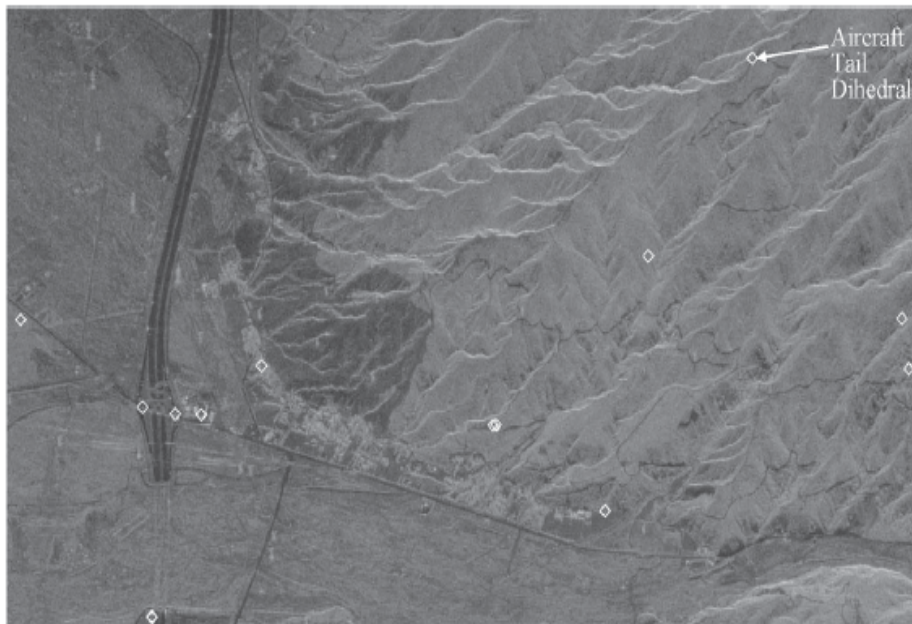

Figure 4.2 Signature Detections Shown for Tail Dihedrals from Rogers [7]

Bibliography

1. William L. Cameron, "Feature Motivated Polarization Scattering Matrix Decomposition" in *IEEE Radar Conference*, pp. 549-557, 1990.
2. P.L. Uslenghi (Ed.), J.R. Huynen (Auth.), Phenomenological Theory of Radar Targets, Academic Press, New York (1978).
3. William L. Cameron, Houra Rais, "Conservative Polarimetric Scatterers and Their Role in Incorrect Extensions of the Cameron Decompositions," *IEEE Transactions on Geoscience and Remote Sensing*, vol. 44, no. 12, pp. 3506-3516, December 2006.
4. William L. Cameron, Houra Rais, "Polarization Symmetric Scatterer Metric Space," *IEEE Transactions on Geoscience and Remote Sensing*, vol. 47, no. 4, pp. 1097-1107, April 2009.
5. William L. Cameron, Houra Rais, "Derivation of a Signed Cameron Decomposition Asymmetry Parameter and Relationship of Cameron to Huynen Decomposition Parameters," *IEEE Transactions on Geoscience and Remote Sensing*, vol. 49, No. 5, pp. 1677-1688, May 2011.

6. William L. Cameron, Houra Rais, "Polarization Scatterer Feature Metric Space," *IEEE Transactions on Geoscience and Remote Sensing*, vol. 51, no. 6, pp. 3638-3647, June 2013.
7. George W. Rogers, Houra Rais, and William L. Cameron, "Polarimetric SAR Signature Detection Using the Cameron Decomposition," *IEEE Transactions on Geoscience and Remote Sensing*, vol. 52, no. 1, pp. 690-700, January 2014.
8. Paul Huray, The Foundations of Signal Integrity, John Wiley & Sons, Inc. pp. xiii-xx, 2010.
9. Constantine A. Balanis, Advanced Engineering Electromagnetics, 2nd Ed., pp. 146-162, John Wiley & Sons, Inc., 2012.

Appendix A: MATLAB Cameron Decomposition Script

The MATLAB script presented below processes input scattering matrix parameters to determine the scatterer's reciprocity, asymmetry, symmetry, and scatterer type. If the scatterer type cannot be matched to a known scatterer type then the script's output will indicate to the user that the scatterer type is unidentified. The script includes the computations presented in chapter 3 and the process flow from Figure 3.1. Table A.1 presents the various outputs generated from a set of inputs including known asymmetric and symmetric scatterer types. The following script processes inputs, entered manually, for an asymmetric left helix scatterer type, and returns the outputs that would be expected for such a scatterer type.

```
P=[1 0 0 0; 0 0.5 0.5 0; 0 0.5 0.5 0; 0 0 0 1]; %Projection operator for reciprocal state
HH=1; %Define matrix components
HV=i;
VH=-i;
VV=-1;
Sm=[HH HV; VH VV]; %Scattering matrix
Sv=[HH;HV;VH;VV]; %Scattering Vector
I=eye(4); %Define identity matrix
Svrec=P*Sv; %Define reciprocal component of the scattering vector
Smrec=[Svrec(1) Svrec(2); Svrec(3) Svrec(4)]; %Define reciprocal component of the
scattering vector
Orth=I-P; %Operator scattering matrix orthogonal to the reciprocal state space
Sorth=Orth*Sv; %Scattering vector component orthogonal to the reciprocal state space
Svnorm=norm(Sv);%Compute norm of scattering matrix
Svunit=Sv/Svnorm; %Normalized unit vector S
```

```

Theta_rec=acosd(norm(P*Svunit));%Compute reciprocal angle
Svalpha=[1/sqrt(2); 0; 0; 1/sqrt(2)]; %Define Pauli basis decomposition components
Svbeta=[1/sqrt(2); 0; 0; -1/sqrt(2)];
Svgamma=[0; 1/sqrt(2); 1/sqrt(2); 0];
Svalpha_unit=Svalpha/norm(Svalpha);%Normalized unit vector
Svbeta_unit=Svbeta/norm(Svbeta);
Svgamma_unit=Svgamma/norm(Svgamma);
Alpha=(HH+VV)/sqrt(2);%Define Pauli basis decomposition coefficients
Beta=(HH-VV)/sqrt(2);
Gamma=(HV+VH)/sqrt(2);
if Theta_rec<=45
    fprintf('Reciprocal scatterer \n')
    if abs(Beta)^2==abs(Gamma)^2&&abs(Beta)^2>0&&abs(Gamma)^2>0    if
Beta*Gamma'+Beta'*Gamma>=0
        Theta=45;
        if Beta*Gamma'+Beta'*Gamma==0
            S=Sm
            fprintf('Scatterer is an asymmetric scatterer.\n')
            Shl=[1; i; i; -1];
            n=0;
            if acosd(abs(dot(Sv,Shl)/norm(Sv)))<5&&HV==VH
                fprintf('Scatterer is a left helix.\n')
                n=n+1;
            end
            Shr=[1; -i; -i; -1];
            if acosd(abs(dot(Sv,Shr)/norm(Sv)))<5&&HV==VH
                fprintf('Scatterer is a right helix.\n')
                n=n+1;
            end
            if n<1
                fprintf('Scatterer is an unidentified asymmetric scatterer.\n')
            end
        else
            D=dot(Svrec,Svalpha_unit)*Svalpha_unit+dot(Svrec,(cos(Theta)*Svbeta_unit+sin(Theta)
            *Svgamma_unit))*(cos(Theta)*Svbeta_unit+sin(Theta)*Svgamma_unit);
            Tau=acosd(abs(dot(Svrec,conj(D))/(dot(norm(Svrec),norm(D)))));
            if Tau<=22.5;
                psi=-0.5*atand(dot(D,conj(Svgamma_unit))/dot(D,conj(Svbeta_unit)));
                R_psi=[cos(psi) -sin(psi); sin(psi) cos(psi)];%Define rotation matrices
                R_minuspsi=[cos(psi) sin(psi); -sin(psi) cos(psi)];
                Dm=[D(1) D(2); D(3) D(4)];
                Sd=R_psi*Dm*R_minuspsi;
                Sdv=[Sd(1);Sd(2);Sd(3);Sd(4)];
        end
    end
end

```

```

if acosd(abs(dot(Sdv,(D)/norm(Sdv))))<5
    S=Sm
    fprintf ('Scatterer is a symmetric scatterer.\n')
    n=0;
    S_diplane=[1/sqrt(2); 0; 0; -1/sqrt(2)];
    if acosd(abs(dot(Sv,S_diplane)/norm(Sv)))<5
        fprintf('Scatterer is a diplane.\n')
        n=n+1;
    end
    S_dipole=[1; 0; 0; 0];
    if acosd(abs(dot(Sv,S_dipole)/norm(Sv)))<5
        fprintf ('Scatterer is a dipole.\n')
        n=n+1;
    end
    S_cylinder=[2/sqrt(5); 0; 0; 1/sqrt(5)];
    if acosd(abs(dot(Sv,S_cylinder)/norm(Sv)))<5
        fprintf ('Scatterer is a cylinder.\n')
        n=n+1;
    end
    S_narrowdiplane=[2/sqrt(5); 0; 0; -1/sqrt(5)];
    if acosd(abs(dot(Sv,S_narrowdiplane)/norm(Sv)))<5
        fprintf ('Scatterer is a narrow diplane.\n')
        n=n+1;
    end
    S_qtrwave=[1/sqrt(2); 0; 0; i/sqrt(2)];
    if acosd(abs(dot(Sv,S_qtrwave)/norm(Sv)))<5
        fprintf ('Scatterer is a quaterwave device.\n')
        n=n+1;
    end
    if n<1
        fprintf ('Scatterer is an unidentified symmetric scatterer.\n')
    end
end
else
    S=Sm
    fprintf('Scatterer is an asymmetric scatterer.\n')
    fprintf('Scatterer is an unidentified asymmetric scatterer.\n')
end
end
end
if Beta*Gamma'+Beta'*Gamma<0
    Theta=-45;

```



```

D=dot(Svrec,Svalpha_unit)*Svalpha_unit+dot(Svrec,(cos(Theta)*Svbeta_unit+sin(Theta)
*Svgamma_unit))*(cos(Theta)*Svbeta_unit+sin(Theta)*Svgamma_unit);
Tau=acosd(abs(dot(Svrec,conj(D))/(dot(norm(Svrec),norm(D)))));
if Tau<=22.5
    psi=-0.5*atand(dot(D,conj(Svgamma_unit))/dot(D,conj(Svbeta_unit)));
    R_psi=[cos(psi) -sin(psi); sin(psi) cos(psi)];
    R_minuspsi=[cos(psi) sin(psi); -sin(psi) cos(psi)];
    Dm=[D(1) D(2); D(3) D(4)];
    Sd=R_psi*Dm*R_minuspsi;
    Sdv=[Sd(1);Sd(2);Sd(3);Sd(4)];
    if acosd(abs(dot(Sdv,(D)/norm(Sdv))))<5
        S=Sm
        fprintf ('Scatterer is a symmetric scatterer.\n')
        n=0;
        S_diplane=[1/sqrt(2); 0; 0; -1/sqrt(2)];
        if acosd(abs(dot(Sv,S_diplane)/norm(Sv)))<5
            fprintf('Scatterer is a diplane.\n')
            n=n+1;
        end
        S_dipole=[1; 0; 0; 0];
        if acosd(abs(dot(Sv,S_dipole)/norm(Sv)))<5
            fprintf ('Scatterer is a dipole.\n')
            n=n+1;
        end
        S_cylinder=[2/sqrt(5); 0; 0; 1/sqrt(5)];
        if acosd(abs(dot(Sv,S_cylinder)/norm(Sv)))<5
            fprintf ('Scatterer is a cylinder.\n')
            n=n+1;
        end
        S_narrowdiplane=[2/sqrt(5); 0; 0; -1/sqrt(5)];
        if acosd(abs(dot(Sv,S_narrowdiplane)/norm(Sv)))<5
            fprintf ('Scatterer is a narrow diplane.\n')
            n=n+1;
        end
        S_qtrwave=[1/sqrt(2); 0; 0; i/sqrt(2)];
        if acosd(abs(dot(Sv,S_qtrwave)/norm(Sv)))<5
            fprintf ('Scatterer is a quaterwave device.\n')
            n=n+1;
        end
        if n<1
            fprintf ('Scatterer is an unidentified symmetric scatterer.\n')
        end
    end
end

```

```

else
    S=Sm
    fprintf('Scatterer is an asymmetric scatterer.\n')
    fprintf('Scatterer is an unidentified asymmetric scatterer.\n')
end
end
end
if abs(Beta)^2==abs(Gamma)^2&&abs(Beta)^2==0&&abs(Gamma)^2==0
    Theta=45;
D=dot(Svrec,Svalpha_unit)*Svalpha_unit+dot(Svrec,(cos(Theta)*Svbeta_unit+sin(Theta)
*Svgamma_unit))*(cos(Theta)*Svbeta_unit+sin(Theta)*Svgamma_unit);
    Tau=acosd(abs(dot(Svrec,conj(D)))/(dot(norm(Svrec),norm(D))));
    if Tau<=22.5
        psi=45;
        R_psi=[cos(psi) -sin(psi); sin(psi) cos(psi)];
        R_minuspsi=[cos(psi) sin(psi); -sin(psi) cos(psi)];
        Dm=[D(1) D(2); D(3) D(4)];
        Sd=R_psi*Dm*R_minuspsi;
        Sdv=[Sd(1);Sd(2);Sd(3);Sd(4)];
        if acosd(abs(dot(Sdv,conj(D))/norm(Sdv)))<5
            S=Sm
            fprintf('Scatterer is a symmetric scatterer.\n')
            S_triheral=[1/sqrt(2); 0; 0; 1/sqrt(2)];
            if acosd(abs(dot(Sv,S_triheral)/norm(Sv)))<5
                fprintf('Scatterer is a triheral.\n')
            else
                fprintf('Scatterer is an unidentified symmetric scatterer.\n')
            end
        end
    end
else
    S=Sm
    fprintf('Scatterer is an asymmetric scatterer.\n')
    fprintf('Scatterer is an unidentified asymmetric scatterer.\n')
end
end
if abs(Beta)^2~abs(Gamma)^2
    Theta=0.5*atand((Beta*Gamma'+Beta'*Gamma)/(abs(Beta)^2-abs(Gamma)^2));
D=dot(Svrec,Svalpha_unit)*Svalpha_unit+dot(Svrec,(cos(Theta)*Svbeta_unit+sin(Theta)
*Svgamma_unit))*(cos(Theta)*Svbeta_unit+sin(Theta)*Svgamma_unit);
    Tau=acosd(abs(dot(Svrec,conj(D)))/(dot(norm(Svrec),norm(D))));
    if Tau<=22.5
        psi=-0.5*atand(dot(D,conj(Svgamma_unit))/dot(D,conj(Svbeta_unit)));
        R_psi=[cos(psi) -sin(psi); sin(psi) cos(psi)];

```

```

R_minuspsi=[cos(psi) sin(psi); -sin(psi) cos(psi)];
Dm=[D(1) D(2); D(3) D(4)];
Sd=R_psi*Dm*R_minuspsi;
Sdv=[Sd(1);Sd(2);Sd(3);Sd(4)];
if acosd(abs(dot(Sdv,(D)/norm(Sdv))))<5
    S=Sm
    fprintf ('Scatterer is a symmetric scatterer.\n')
    n=0;
    S_diplane=[1/sqrt(2); 0; 0; -1/sqrt(2)];
    if acosd(abs(dot(Sv,S_diplane)/norm(Sv)))<5
        fprintf('Scatterer is a diplane.\n')
        n=n+1;
    end
    S_dipole=[1; 0; 0; 0];
    if acosd(abs(dot(Sv,S_dipole)/norm(Sv)))<5
        fprintf ('Scatterer is a dipole.\n')
        n=n+1;
    end
    S_cylinder=[2/sqrt(5); 0; 0; 1/sqrt(5)];
    if acosd(abs(dot(Sv,S_cylinder)/norm(Sv)))<5
        fprintf ('Scatterer is a cylinder.\n')
        n=n+1;
    end
    S_narrowdiplane=[2/sqrt(5); 0; 0; -1/sqrt(5)];
    if acosd(abs(dot(Sv,S_narrowdiplane)/norm(Sv)))<5
        fprintf ('Scatterer is a narrow diplane.\n')
        n=n+1;
    end
    S_qtrwave=[1/sqrt(2); 0; 0; i/sqrt(2)];
    if acosd(abs(dot(Sv,S_qtrwave)/norm(Sv)))<5
        fprintf ('Scatterer is a quaterwave device.\n')
        n=n+1;
    end
    if n<1
        fprintf ('Scatterer is an unidentified symmetric scatterer.\n')
    end
end
else
    S=Sm
    fprintf('Scatterer is an asymmetric scatterer.\n')
    fprintf ('Scatterer is an unidentified asymmetric scatterer.\n')
end
end
if Theta_rec>45

```

```

S=Sm
fprintf ('Non-reciprocal scatterer \n')
end

```

Reciprocal scatterer

S =

1.0000 + 0.0000i 0.0000 + 1.0000i

0.0000 + 1.0000i -1.0000 + 0.0000i

Scatterer is an asymmetric scatterer.

Scatterer is a left helix.

Similarly, the inputs and outputs are shown below for other known scatterer types.

Right helix input:

HH=1;

HV=-i;

VH=-i;

VV=-1;

Right helix output:

Reciprocal scatterer

S =

1.0000 + 0.0000i 0.0000 - 1.0000i

0.0000 - 1.0000i -1.0000 + 0.0000i

Scatterer is an asymmetric scatterer.

Scatterer is a right helix.

Trihedral input:

HH=1/sqrt(2);

$$\begin{aligned} HV &= 0; \\ VH &= 0; \\ VV &= 1/\sqrt{2}; \end{aligned}$$

Trihedral output:

Reciprocal scatterer

$$S = \begin{pmatrix} 0.7071 & 0 \\ 0 & 0.7071 \end{pmatrix}$$

Scatterer is a symmetric scatterer.

Scatterer is a trihedral.

Diplane input:

$$\begin{aligned} HH &= 1/\sqrt{2}; \\ HV &= 0; \\ VH &= 0; \\ VV &= -1/\sqrt{2}; \end{aligned}$$

Diplane output:

Reciprocal scatterer

$$S = \begin{pmatrix} 0.7071 & 0 \\ 0 & -0.7071 \end{pmatrix}$$

Scatterer is a symmetric scatterer.

Scatterer is a diplane.

Dipole input:

$$\begin{aligned} HH &= 1; \\ HV &= 0; \\ VH &= 0; \end{aligned}$$

$$VV=0;$$

Dipole output:

Reciprocal scatterer

$$S =$$

$$1 \quad 0$$

$$0 \quad 0$$

Scatterer is a symmetric scatterer.

Scatterer is a dipole.

Cylinder input:

$$HH=2/\sqrt{5};$$

$$HV=0;$$

$$VH=0;$$

$$VV=1/\sqrt{5};$$

Cylinder output:

Reciprocal scatterer

$$S =$$

$$0.8944 \quad 0$$

$$0 \quad 0.4472$$

Scatterer is a symmetric scatterer.

Scatterer is a cylinder.

Narrow diplane input:

$$HH=2/\sqrt{5};$$

$$HV=0;$$

$$VH=0;$$

$$VV=-1/\sqrt{5};$$

Narrow diplane output:

Reciprocal scatterer

$$S =$$

$$0.8944 \quad 0$$

$$0 \quad -0.4472$$

Scatterer is a symmetric scatterer.

Scatterer is a narrow diplane.

Quarter-wave device input:

$$HH=1/\sqrt{2};$$

$$HV=0;$$

$$VH=0;$$

$$VV=i/\sqrt{2};$$

Quarter-wave device output:

Reciprocal scatterer

$$S =$$

$$0.7071 + 0.0000i \quad 0.0000 + 0.0000i$$

$$0.0000 + 0.0000i \quad 0.0000 + 0.7071i$$

Scatterer is a symmetric scatterer.

Scatterer is a quaterwave device.

The data above is presented in table A.1 along with data from several arbitrary scatterer input parameters and their respective outputs.

Scatterer Input $\begin{pmatrix} HH & HV \\ VH & VV \end{pmatrix}$	Reciprocal (MATLAB Output)	Symmetric or Asymmetric (MATLAB Output)	Scatterer Type (MATLAB Output)
Left Helix $\begin{pmatrix} 1 & i \\ i & -1 \end{pmatrix}$	Reciprocal scatterer	Scatterer is an asymmetric scatterer.	Scatterer is a left helix.
Right Helix $\begin{pmatrix} 1 & -i \\ -i & -1 \end{pmatrix}$	Reciprocal scatterer	Scatterer is an asymmetric scatterer.	Scatterer is a right helix.
Trihedral $\begin{pmatrix} \frac{1}{\sqrt{2}} & 0 \\ 0 & \frac{1}{\sqrt{2}} \end{pmatrix}$	Reciprocal scatterer	Scatterer is a symmetric scatterer.	Scatterer is a trihedral.
Dipole $\begin{pmatrix} 1 & 0 \\ 0 & 0 \end{pmatrix}$	Reciprocal scatterer	Scatterer is a symmetric scatterer.	Scatterer is a dipole.
Cylinder $\begin{pmatrix} \frac{2}{\sqrt{5}} & 0 \\ 0 & \frac{1}{\sqrt{5}} \end{pmatrix}$	Reciprocal scatterer	Scatterer is a symmetric scatterer.	Scatterer is a cylinder.

Narrow Diplane $\begin{pmatrix} \frac{2}{\sqrt{5}} & 0 \\ 0 & \frac{-1}{\sqrt{5}} \end{pmatrix}$	Reciprocal scatterer	Scatterer is a symmetric scatterer.	Scatterer is a narrow diplane.
Quarter-wave Device $\begin{pmatrix} \frac{1}{\sqrt{2}} & 0 \\ 0 & \frac{i}{\sqrt{2}} \end{pmatrix}$	Reciprocal scatterer	Scatterer is a symmetric scatterer.	Scatterer is a quarterwave device.
Arbitrary input $\begin{pmatrix} 1 & i \\ -i & -1 \end{pmatrix}$	Reciprocal scatterer	Scatterer is a symmetric scatterer.	Scatterer is an unidentified symmetric scatterer.
Arbitrary input $\begin{pmatrix} 1 & 2 \\ 0 & 3 \end{pmatrix}$	Reciprocal scatterer	Scatterer is a symmetric scatterer..	Scatterer is an unidentified symmetric scatterer.
Arbitrary input $\begin{pmatrix} 1 & 0 \\ 0 & 2 \end{pmatrix}$	Reciprocal scatterer	Scatterer is a symmetric scatterer.	Scatterer is an unidentified symmetric scatterer.

Arbitrary input $\begin{pmatrix} 1 & -i \\ -i & 0 \end{pmatrix}$	Reciprocal scatterer	Scatterer is an asymmetric scatterer.	Scatterer is an unidentified asymmetric scatterer.
--	-------------------------	---	--

Table A.1 MATLAB Cameron Decomposition Scattering Matrix Data